



1. General

This NM8N High-voltage (HV) Series Molded Case Circuit Breaker is specially designed for handling high-voltage electrical system, capable to break heavy loaded electrical circuit systems under wide range of operating temperature of $-40^{\circ}\text{C} \sim +70^{\circ}\text{C}$. The characteristics of this Circuit Breaker is its capability to break circuit with zero arcing, which is an ideal component for meeting the requirements of many systems such as the solar (PV) power generation system. This Circuit Breaker works perfectly up to the maximum working voltage of AC 1150V, which can effectively protects electrical systems like the output loading of the string Inverters, and others such as the loading capacity of the AC combiner box in the photovoltaic systems.

2. Operating conditions

2.1 Temperature:

Operating and storage temperature is $-40^{\circ}\text{C} \sim +70^{\circ}\text{C}$; the average value within 24 hours does not exceed $+35^{\circ}\text{C}$; when the ambient temperature is $-40^{\circ}\text{C} \sim +70^{\circ}\text{C}$, users need to consider derating or temperature compensation whose details can be referred to in Page

2.2 Altitude: $\leq 2000\text{m}$;

2.3 Pollution grade: Grade 3;

2.4 IP grade: IP40

2.5 Air conditions:

At mounting site, relative humidity not exceed 50% at the max temperature of $+40^{\circ}\text{C}$, higher relative humidity is allowable under lower temperature. For example, RH could be 90% at $+20^{\circ}\text{C}$, special measures should be taken to occurrence of dews.

3.Type designation

Model fast selection guide

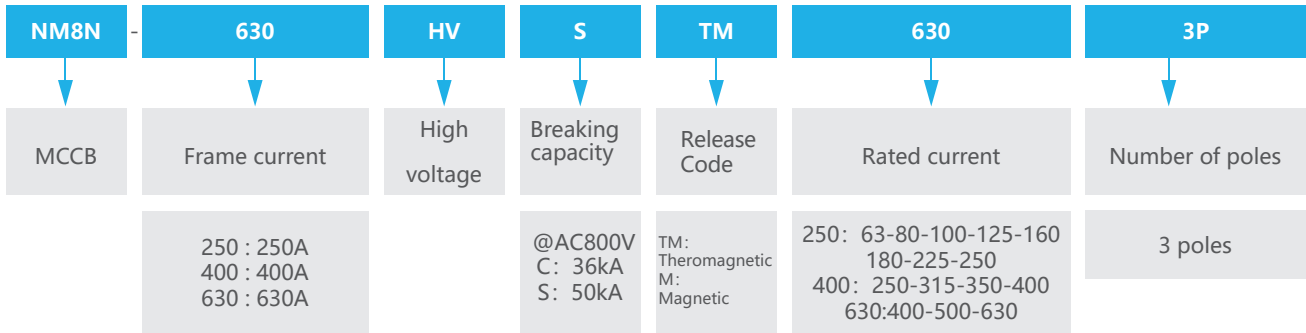

Note: example of model purchase

NM8N-630 HV S TM 630 3P

This means to order an NM8N high voltage (HV) series, with 630 frame, breaking capacity of 50kA, thermomagnetic power distribution protection type, rated working current 630A, 3 poles AC moulded case circuit breaker.

4. Technical data

Model	NM8N-250HV		NM8N-400HV		NM8N-630HV		
Frame Current Inm(A)	250		400		630		
Rated Current In (A),40°C	63-80-100-125-160-180-200-225-250		250-315-350-400		400-500-630		
Insulation Voltage Ui (V)			1250				
Rated impulse withstand voltage Uimp (kV)	8		12		12		
Rated Voltage Ue (V)			690/800/1000/1150				
Number of Poles			3P				
Breaking Capacity	C	S	C	S	C	S	
Rated Ultimate Breaking Capacity Icu (kA)	AC690V	50	80	50	80	50	80
	AC800V	36	50	36	50	36	50
	AC1000V	15	30	25	35	25	35
	AC1150V	10	10	10	10	10	10
Rated Service Breaking Capacity Ics (kA)	AC690V	50	80	50	80	50	80
	AC800V	36	36	36	50	36	50
	AC1000V	15	15	15	20	15	20
	AC1150V	10	10	10	10	10	10
Release type	TM (Theromagnetic type) ,M (Magnetic type)						
Mechanical Durability	15000		15000		15000		
Electrical durability	1500		1500		1500		
Outline sizes 	Width	106		140		140	
	Height	200		250		250	
	Depth	120		135		135	



5. Release

5.1 Theromagnetic type Release (TM)

The setting value of Theromagnetic type Release (TM) of NM8N-250HV, 400HV and 630HV High-voltage (HV) Series Molded Case Circuit Breakers can be adjusted to meet the protection requirements.

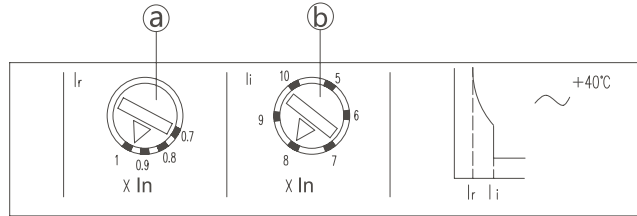

Theromagnetic Release Data Sheet

Theromagnetic type Release (TM)	250	400	630
Number of Poles	3P		
Current specification	63-80-100-125-160-180-200-225-250	250-315-350-400	400-500-630
Over-load Protection			
Current setting (A)	0.7-0.8-0.9-1.0		
$I_r = I_n \times$ Accuracy	0.7-0.8-0.9-1.0		
Short-circuit Instantaneous Protection			
Current setting (A)	10(63A ~ 100A) 7-8-9-10-11-12(125A ~ 160A) 5-6-7-8-9-10(180A ~ 250A)	5-6-7-8-9-10	
$I_i = I_n \times$			
Accuracy (%)	±20		

5.2 Magnetic type Release (M)

5.2.1 Motor Startup Characteristics

Most of power motors adopt three-phase asynchronous induction motors (AIM) design for various applications in the industry. Most AIMs use direct startup strategy known as the Full-Voltage starting, which starts the motor by feeding unlimited electric power directly into the motor. The asynchronous motor needs a very large startup current in the range of approximate 4 - 7 times of the rated current to kick start the motor, the high current is needed due mainly to the inertia of the motor when it is kick started from its idle state. Although the revolving speed of the rotor cannot reach its normal rated speed instantaneously during the kick-starting stage, the relatively high speed of the rotor windings cuts the magnetic field at a high speed, thus producing very large current in the motor system. This large current in the rotor induces a large magnetic field which in turn interacts with the stator winding, resulting in a rapidly increase of current loading in the system.

5.2.2 Startup Parameters

Rated Current (I_n): The rating of the electric current of the motor under normal operation.

Startup Current (I_d): The start up current of the motor which is rated at an average of $7.2 \times I_n$, dependent on the operation conditions.

Startup Peak Current (I_d'): The transient current during the first two half cycling waves after the motor is powered up is generally in the order of $14 \times I_n$.

Startup Time (t_d): The startup time for starting the motor from idle to fully operation stage is generally approximate 0.5s - 20s.

5.2.3 The Important Roles of the Protection Device in the Direct Startup System

When the conventional tripping current of the magnetic Release is not set properly in the electric rotor system, the Circuit Breaker may operate mistakenly by considering the large startup current of the motor as the system is in the short-circuit state. Similarly, the heat that has been generated by the large startup current during the kick start state of the motor, will cause the thermal relay to trip off the system mistakenly. In the case of a contactor system it is necessary to ensure the current can be disconnected from the motor during the startup stage, especially when the motor needs an electric or regenerative braking capability. This can be achieved by reducing the capacity of the system generally. Hence to avoid the misoperation of protection device within the motor system that caused by the influence of the start up current, the following conditions are advised to follow:

- To ensure the entire inverse time characteristic curve of the independent thermal relay well above the start up current.
- To ensure the short-circuit current trip setting of the Circuit Breaker that with magnetic protection capacity, should be greater than the peak startup current of the motor.

5.2.4 Protection Scheme

This NM8N-HV Series Product has been designed for providing solutions for the starting up, to control and to protect all different variants of three-phase asynchronous motor systems.

Three elements protection adopts: electromagnetic Protection Circuit Breaker + Contactor + Thermal Relay

Electromagnetic Protection Circuit Breaker can be used for short-circuit protection, the Contactor can be used for motor operation, and the Thermal Relay can be used for system overload, phase loss and phase imbalance protections.

The current range of Electromagnetic Protection Circuit Breaker is 63-630A, the adjustable range is 9~14In, and the accuracy is 20%. It is especially suitable for application in the classical three elements protection scheme.

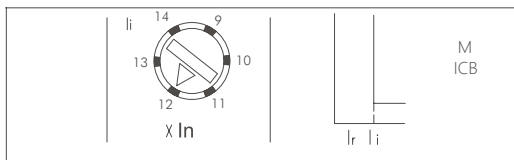

Magnetic Release Data Sheet

Magnetic type Release (M)	250	400	630
Number of Poles	3P		
Short-circuit Instantaneous Protection			
Current setting (A)	12(63A ~ 100A)	9-10-11-12-13-14	
li=InX	9-10-11-12-13-14(125A ~ 250A)	9-10-11-12-13-14	
Accuracy (%)	±20		

6.Tripping Curve

6.1 Tripping Characteristic Curve of Power distribution Protection

NM8N-250HV(63A, 80A, 100A)

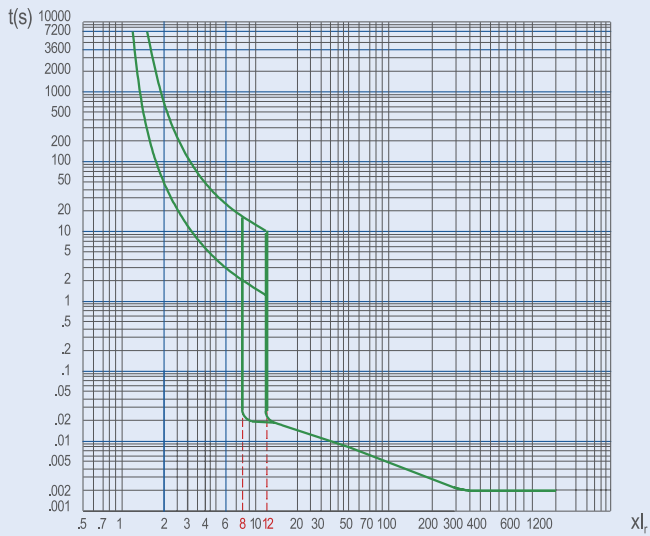

NM8N-250HV(125A, 160A)

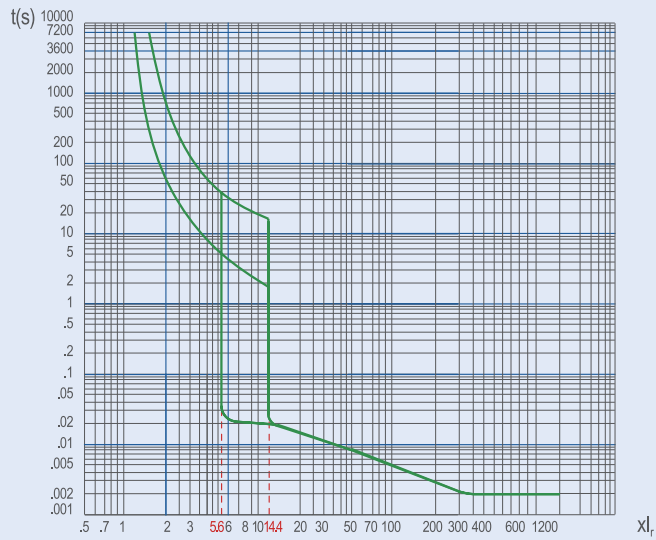

NM8N-250HV(180A, 200A, 225A, 250A)

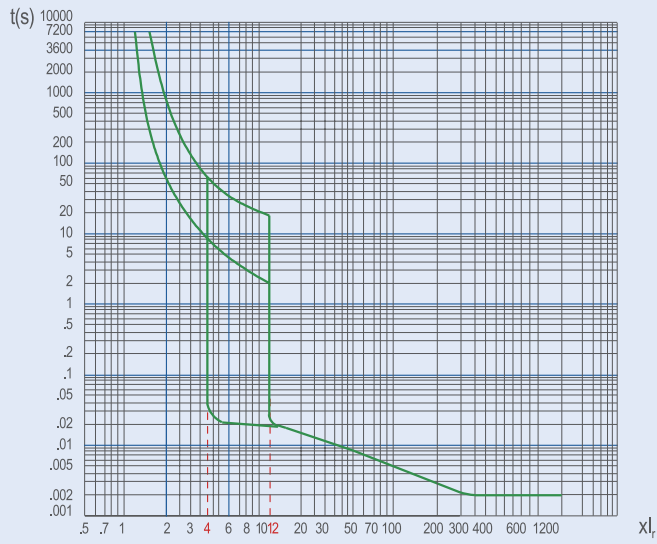

NM8N-400HV(250A, 315A, 350A, 400A)

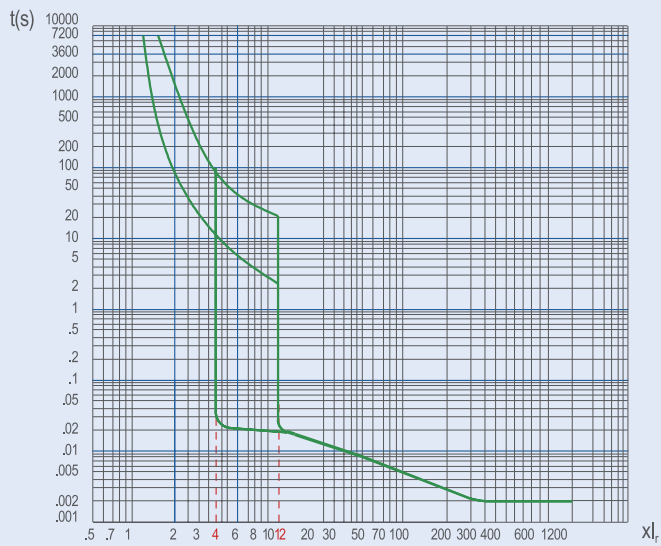

NM8N-630HV((400A,500A and 630A))

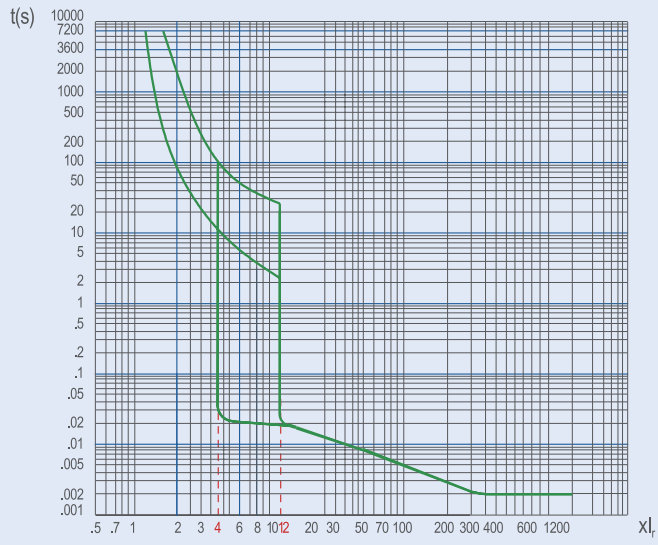

6.2 Tripping Characteristic Curve of Motor Protection

NM8N-250HV(63A,80A and 100A)

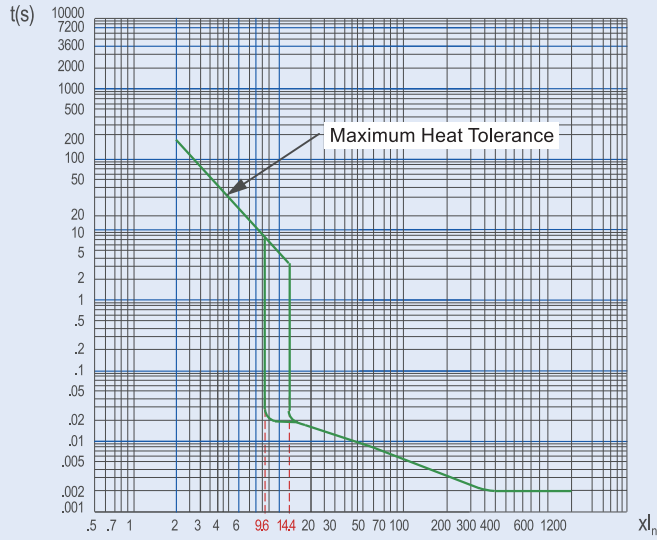

NM8N-250HV(125A,160A,180A,200A,225A and 250A)

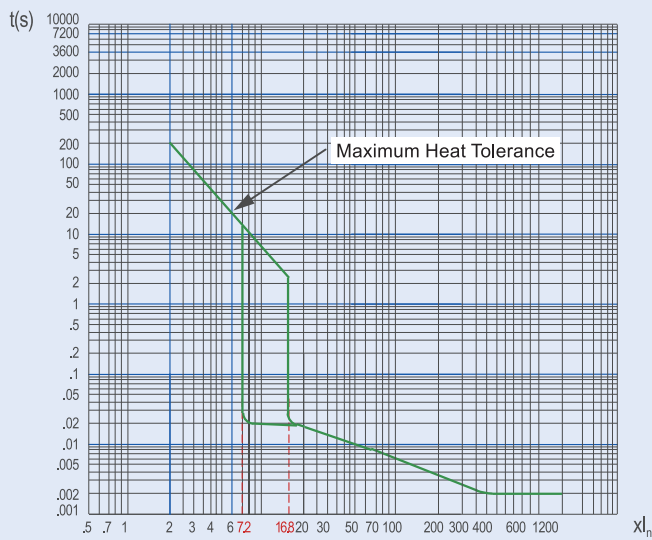

NM8N-400HV(250A,315A,350A and 400A)

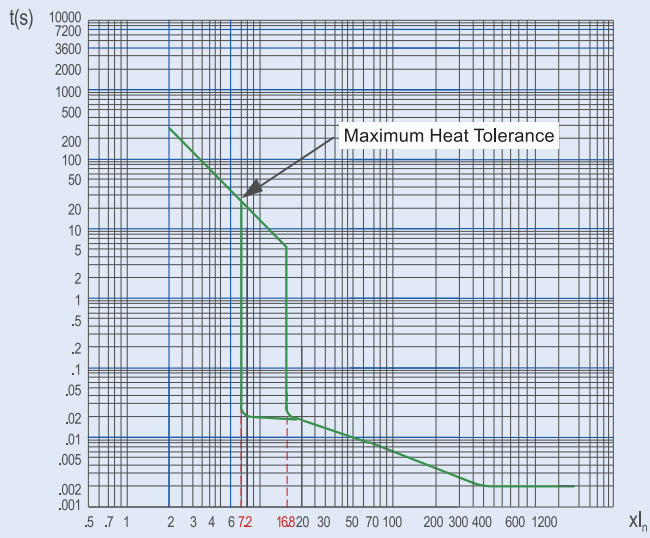

NM8N-630HV(400A,500A and 630A)

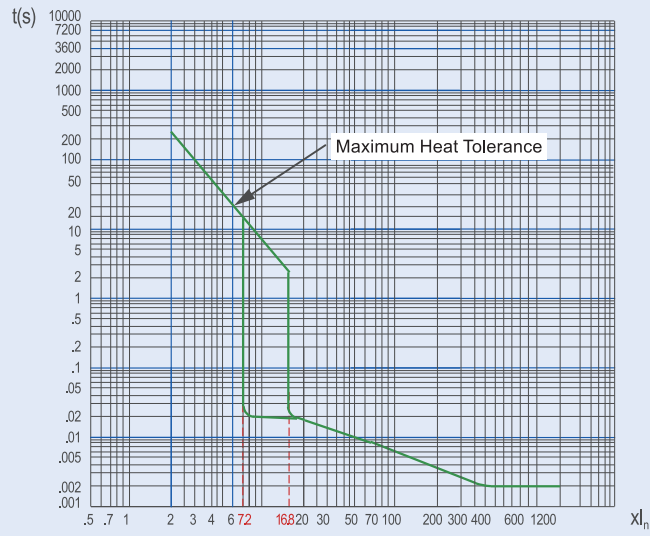

7. Mounting of circuit breaker

7.1 Modes of down-lead

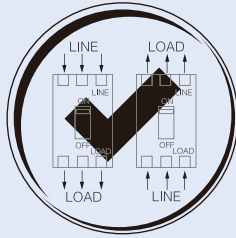

Incoming Methods

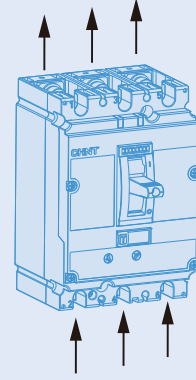
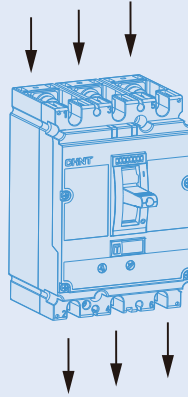

7.2 Modes of mounting

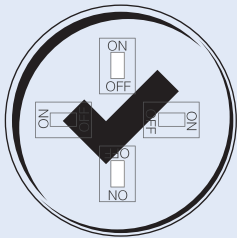

Installation Methods

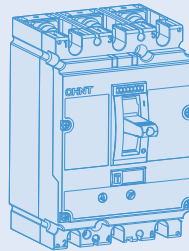
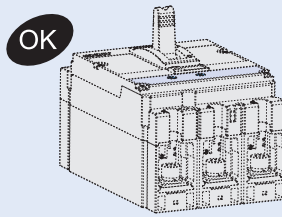

OK

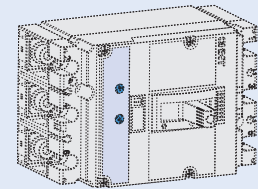

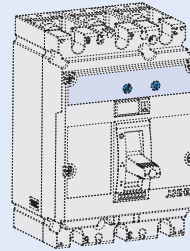

OK

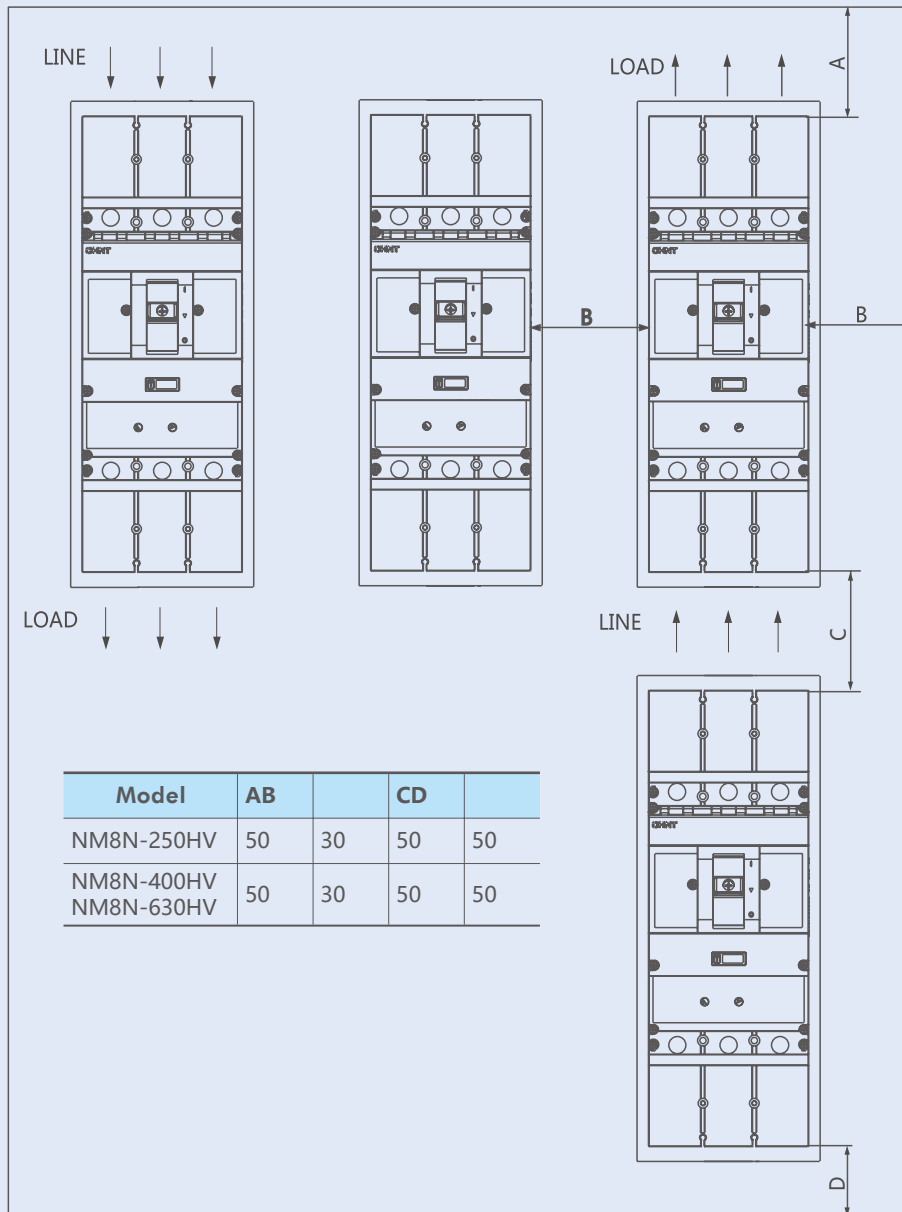

OK

7.3 Safe distance



 Minimum Mounting distance must be ensured.

8. Overall and Mounting Dimensions

8.1 NM8N-250HV

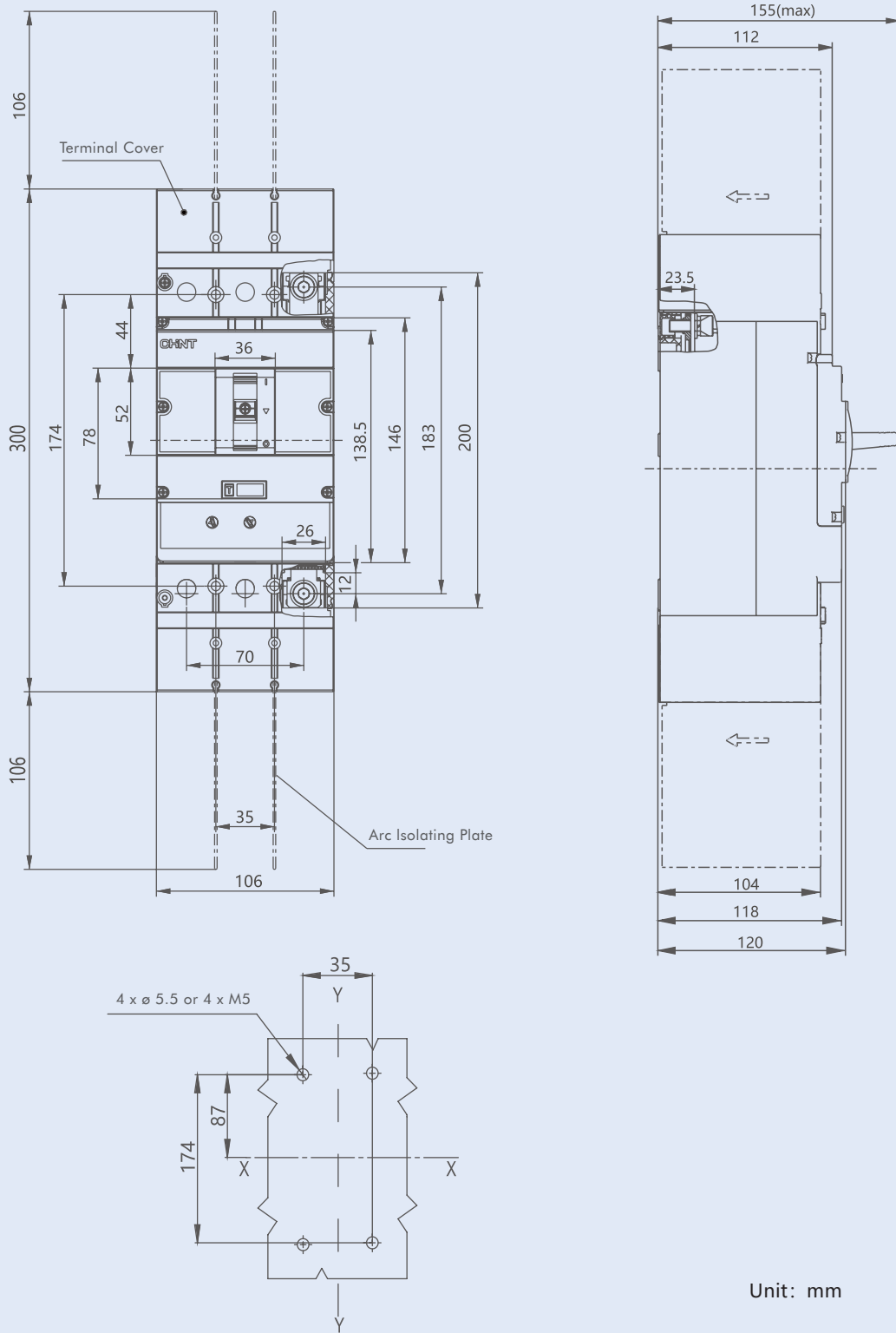

Unit: mm

8.2 NM8N-400/630HV

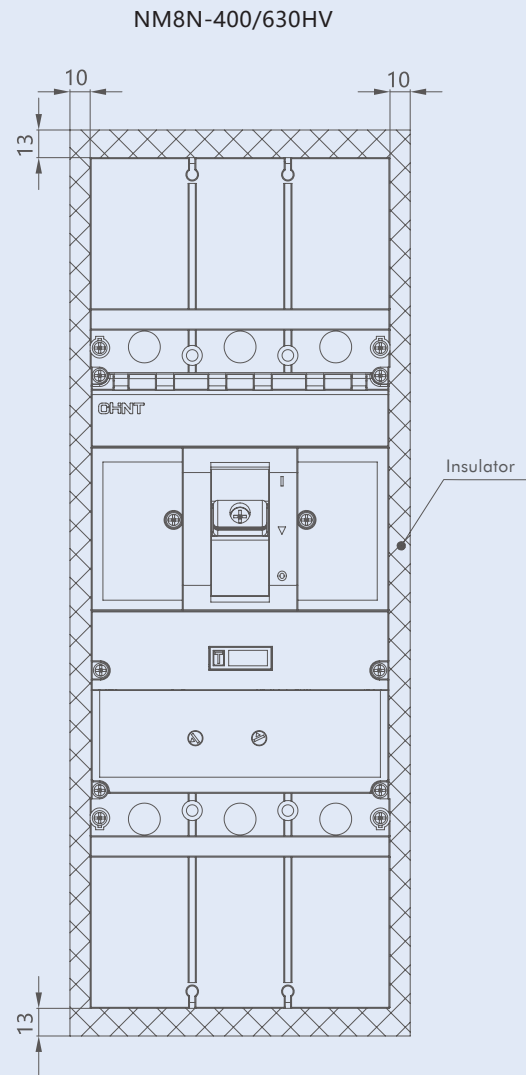
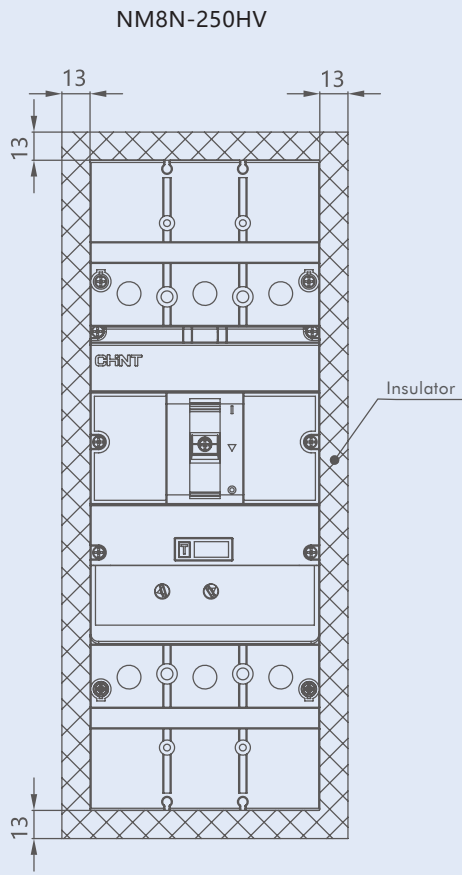

Unit: mm

8.3 Panel front hole opening

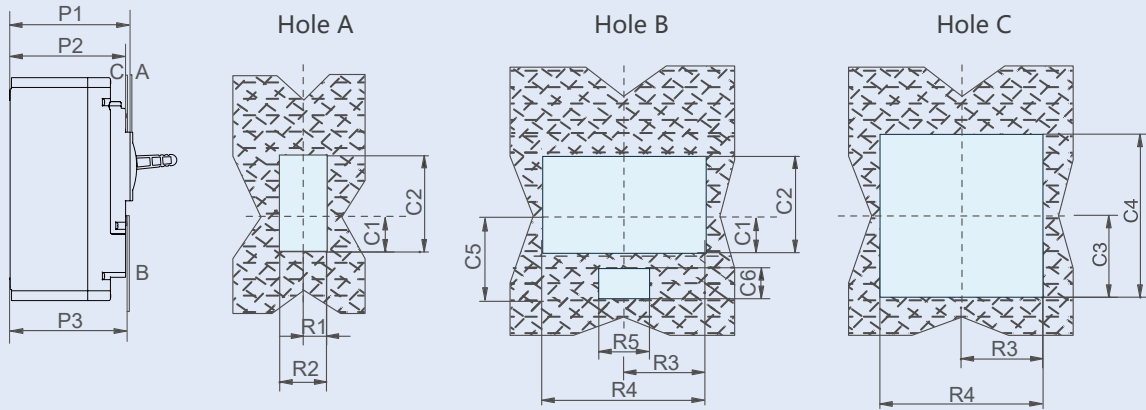

Size type	Size code	Product Model	
		NM8N-250HV	NM8N-400HV/630HV
opening size	P1	121	136
	P2	112.5	126
	P3	118.5	132
	R1	18.5	28
	R2	37	56
	R3	53.5	70.5
	R4	107	141
	R5	29	/
	C1	9.5	13.5
	C2	53	78
	C3	73.5	99
	C4	139.5	190
	C5	35.5	/
	C6	12	/

8.4 Front connection plate

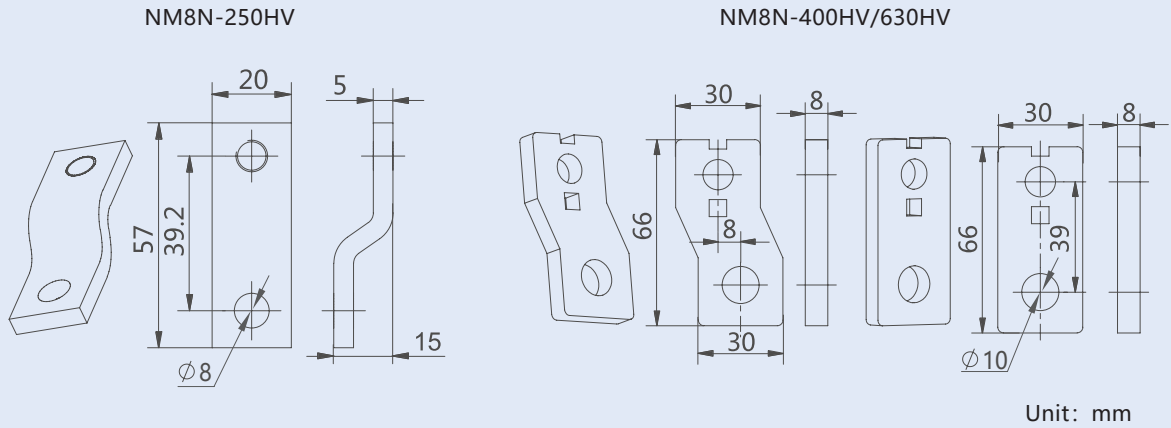

8.5 Wiring

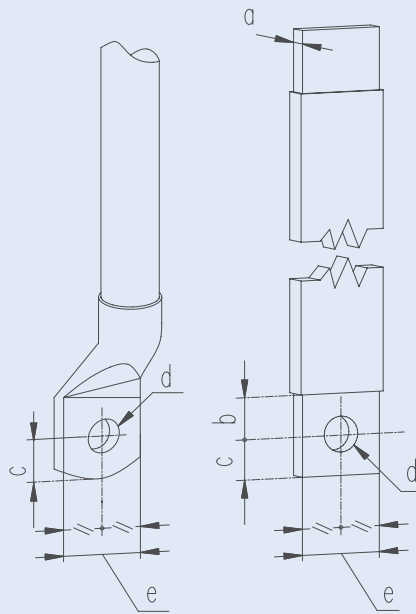

Unit: mm

Size	a	b	c	d	e
NM8N-250HV	6	≥ 9.5	≤ 12	Φ8.5	≤ 25
NM8N-400HV NM8N-630HV	8	≥ 15	≤ 12.5	Φ10.5	≤ 30

9. Accessories characteristics and installation

9.1 AX Auxiliary contact

9.1.1 Function

Remotely indicate the circuit breaker's making (on) or breaking / tripping (OFF) status, connected to the auxiliary circuit of the circuit breaker.



9.1.2 Model description

AX 21-M8

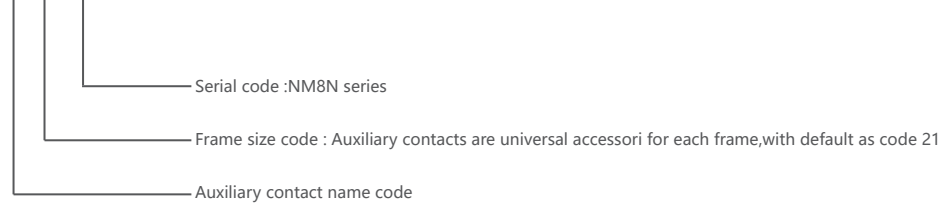

9.1.3 Circuit Breaker status indication

Breaker is at breaking / free trip status	
Breaker is at making status	

9.1.4 Electrical characteristics

Rated voltage (V)	Rated current (A)	
	AC-15	DC-13
AC 110	5	—
AC 240	4	—
AC 415	2	—
DC 110	—	0.25
DC 220	—	0.25

9.1.5 Wiring diagram

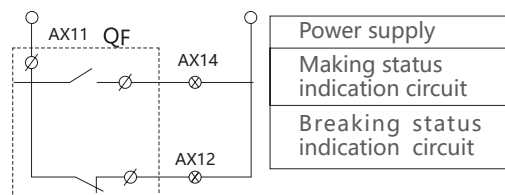

9.2 AL Alarm contact

9.2.1 Function



It is mainly used to provide a signal when the load of the circuit breaker is overloaded, short-circuited or undervoltage, or tripped.

The reasons for the failure of the alarm signal are:

- Over-load or short-circuit
- Undervoltage trip
- Manual free trip

9.2.2 Model description

AL 21-M8

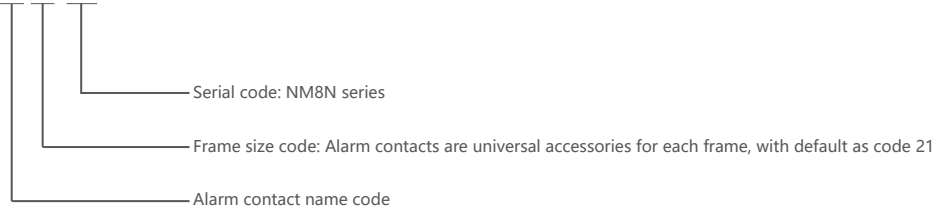

9.2.3 Circuit Breaker status indication

Breaker is at breaking / Making status	
Breaker is at free trip status	

9.2.4 Electrical characteristics

Rated voltage (V)	Rated current (A)	
	AC-15	DC-13
AC 110	5	—
AC 240	4	—
AC 415	2	—
DC 110	—	0.25
DC 220	—	0.25

9.2.5 Wiring diagram

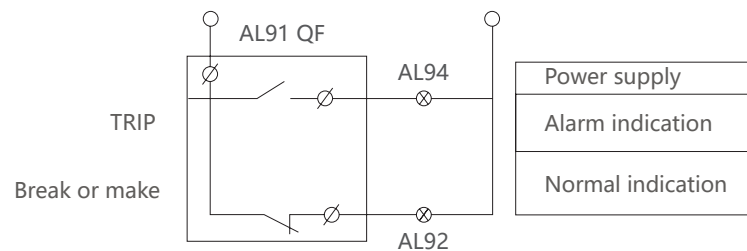

9.3 SHT Shunt release

9.3.1 Function

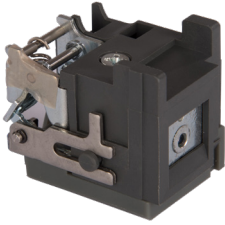

Shunt releases operate according to electrical signals, enabling remote control and automatic control of circuit breakers. When the supply voltage is equal to any voltage between 70% and 110% of the rated control power supply voltage, the shunt release should enable the circuit breaker to operate reliably.

9.3.2 Model description

SHT 22-M8NHV AC48V

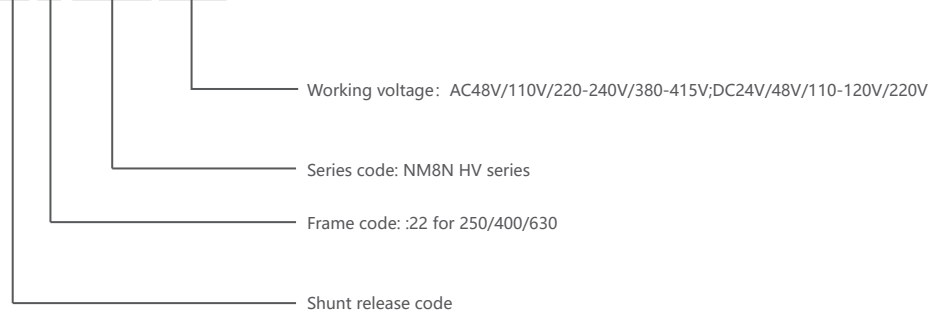

Note: Shunt release of 400/630A frame and 250A frame is compatible.

9.3.3 Electrical characteristics

Frame	Power loss (W)							
	AC48V	AC110V	AC220-240V	AC380-415V	DC24V	DC48V	DC110-120V	DC220V
250/400/630A	2.3	2.5	2.2	2.5	2.2	2.5	2.5	2.5

9.3.4 Trip characteristics

Can be powered for a long time. Response time: pulse type > 20ms, <60ms

9.3.5 Wiring diagram

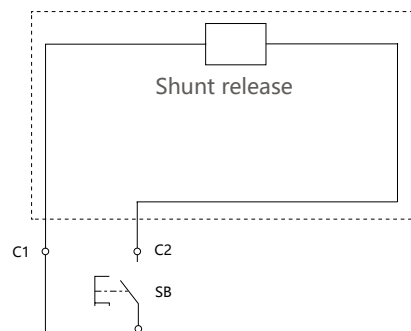

Note: When the rated control power supply voltage DC24V shunt release is used, the maximum length of the copper wire (each of the two wires) must meet the following table:

rated control voltage U_s (DC24V)	Conductor cross-sectional area	
	1.5mm ²	2.5mm ²
100% U_s	150m	250m
85% U_s	100m	160m

9.4 UVT Under-voltage release

9.4.1 Function



Realize the under-voltage protection function of the circuit breaker, open the circuit breaker when the power supply voltage is too low, and protect the electrical equipment.

- When the supply voltage drops (even slowly) to 70% to 35% of the rated control supply voltage, the undervoltage trips The breaker should open the circuit breaker reliably.
- When the supply voltage is equal to or greater than 85% of the rated control supply voltage of the undervoltage release, the circuit breaker should be guaranteed to close.
- When the supply voltage is less than 35% of the rated control supply voltage of the undervoltage release, the undervoltage release should prevent the circuit breaker.

9.4.2 Model description

UVT 22-M8NHV AC48V

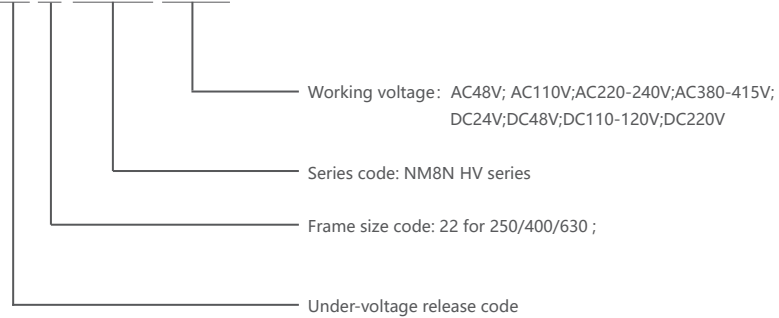

Note: Shunt release of 400/630A frame and 250A frame is compatible.

9.4.3 Electrical characteristics

Frame	Power loss (W)							
	AC48V	AC110V	AC220-240V	AC380-415V	DC24V	DC48V	DC110-120V	DC220V
250/400/630A	1.5	1.5	2.2	3	0.8	1.5	2	2.5

9.4.4 Wiring diagram

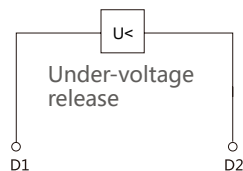

9.5 FCP front connection plate

9.5.1 Function



Make the circuit breaker have a flexible wiring mode. By installing this accessory, the pole spacing can be increased to increase the electrical gap between adjacent poles at the inlet and outlet ends of the circuit breaker and enhance the safety between lines.

9.5.2 Model description

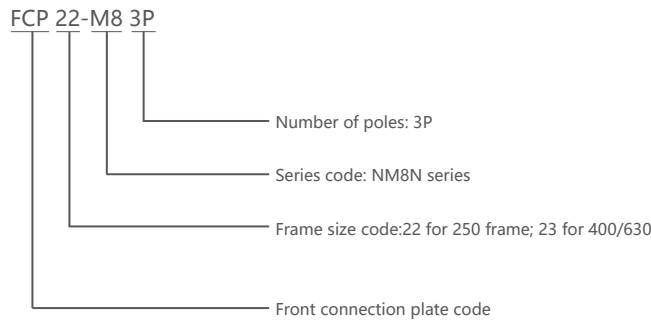

9.5.3 Internal accessories installation diagram

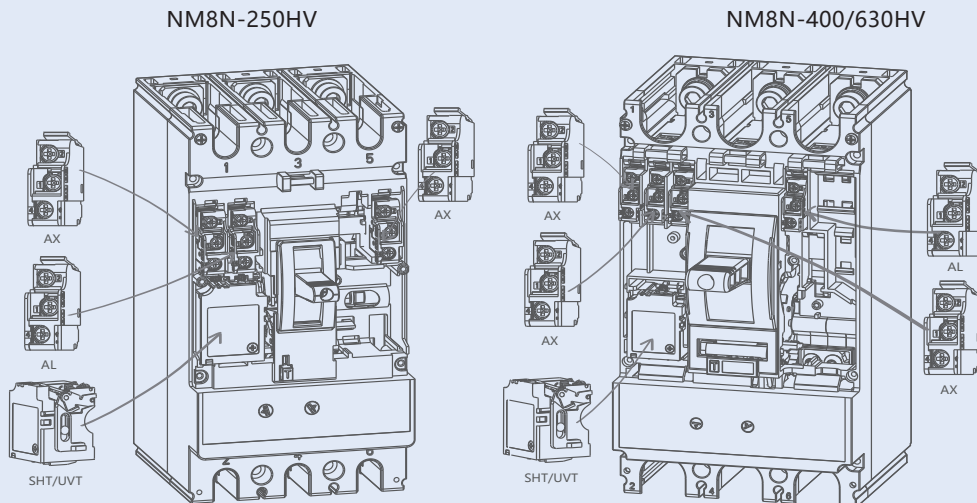

AX	Auxiliary Contact
AL	Alarm Contact
SHT	Shunt Release
UVT	Under-voltage Release

AX	ON	AX12 ——— AX11 AX14 ——— AX11
	OFF	AX12 ——— AX11 AX14 ———
AL	OFF & ON	AL92 ——— AL91 AL94 ———
	TRIP	AL92 ——— AL91 AL94 ——— AX11

9.6 CRH Extended rotary handle

9.6.1 Function

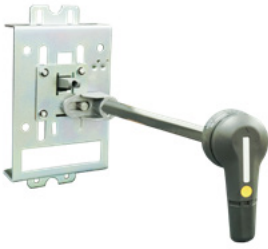

Using a unique design driving structure, by rotating the handle to achieve the circuit breaker closing, switch and re-close operation.

- Three position indication includes O (open), I (closed) and free tripping;
- The circuit breaker can hang 1 to 3 padlocks at OFF position, with a diameter of 5 to 8 mm, thus, in order to prevent the circuit breaker to close and switch gear to open;
- When the circuit breaker is at ON position, cabinet door cannot open under the action of the rotating handle (cabinet door can be opened by the emergency unlocking device on the handle in emergency situation).

9.6.2 Model description

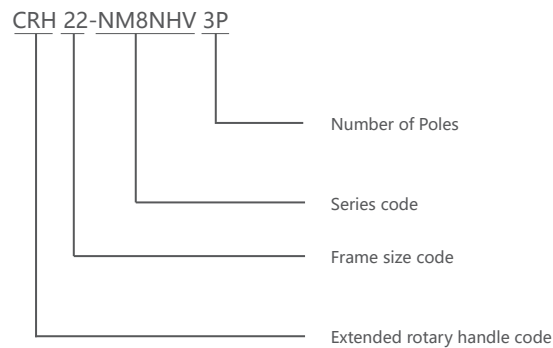

9.6.3 Handle size drawing

NM8N-250HV

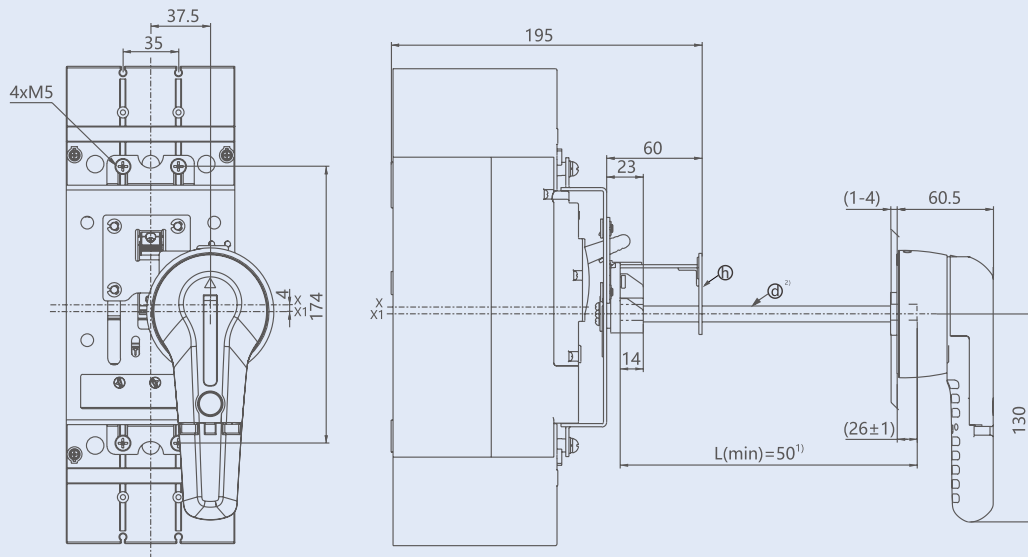

Note: 1) When $L \geq 150$, in order to avoid the shaft sagging, h support plate need to be installed; When $50 \leq L \leq 90$, support plate is not needed;
 2) Standard length of rotating shaft $L=320$.

NM8N-400/630HV

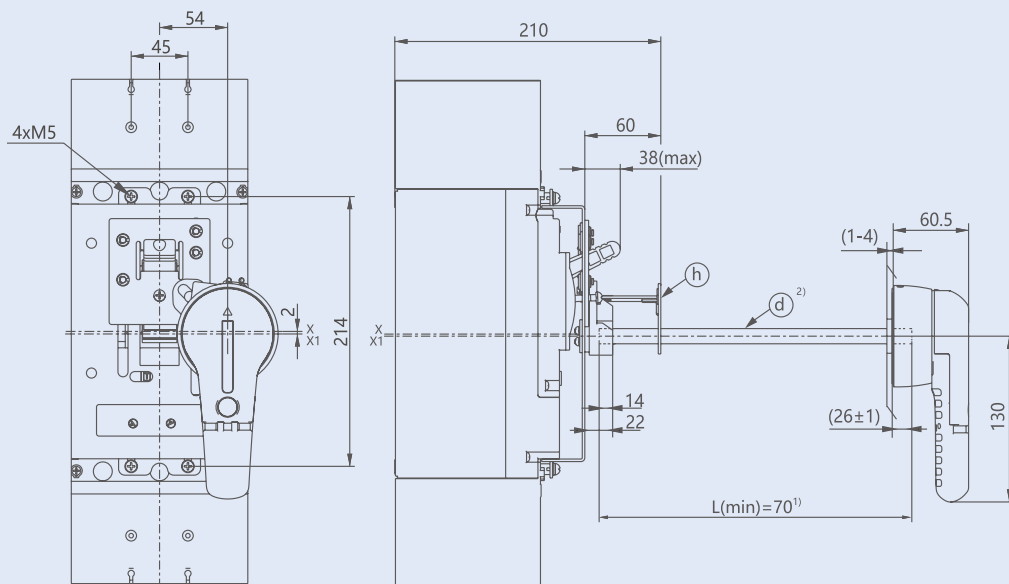

Note: 1) When $L \geq 150$, in order to avoid the shaft sagging, h support plate need to be installed; When $70 \leq L \leq 90$, support plate is not needed;
 2) Standard length of rotating shaft $L=260$.

9.6.4 Installation diagram

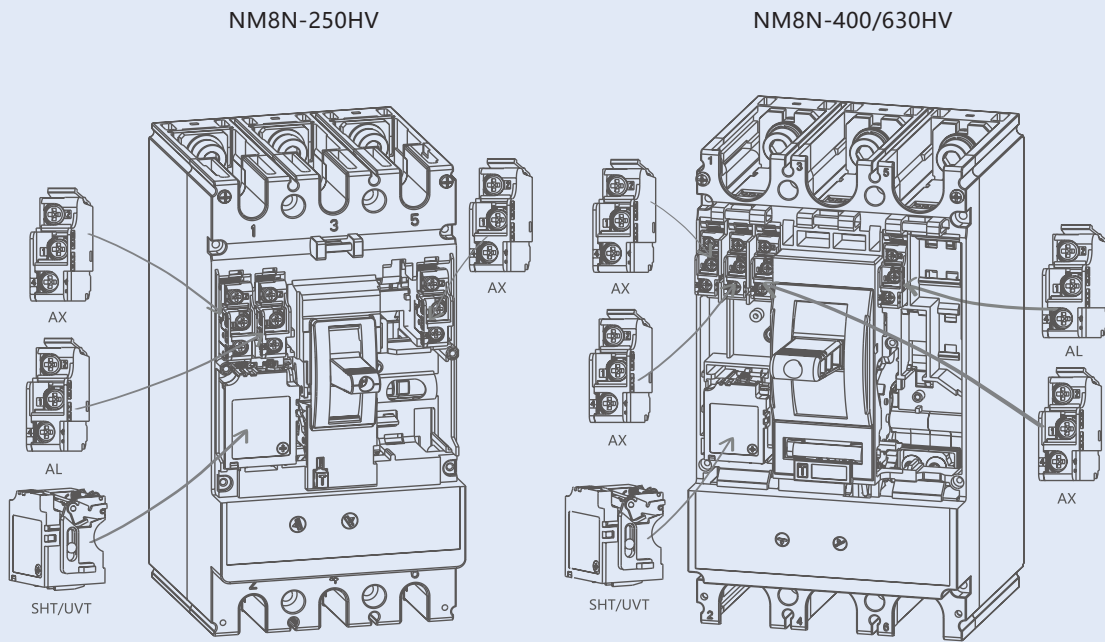

AX	Auxiliary Contact
AL	Alarm Contact
SHT	Shunt Release
UVT	Under-voltage Release

AX	ON	AX12 ——— AX11 AX14 ———
	OFF	AX12 ——— AX11 AX14 ———
AL	OFF & ON	AL92 ——— AL91 AL94 ———
	TRIP	AL92 ——— AL91 AL94 ———

10. Supplemented Technical Information

10.1 Power loss

Altitude derating coefficient table	Product model Rated current (A)	Fixed breaker internal resistance per pole (mΩ)	Power loss per pole (W)
NM8N-250HV	63	1.7	6.7
	80	1.3	8.3
	100	0.88	8.8
	125	0.7	10.9
	160	0.55	14.1
	180	0.55	17.8
	200	0.55	22.0
	225	0.4	20.3
	250	0.4	25.0
NM8N-400HV/630HV	250	0.35	21.9
	315	0.25	24.8
	350	0.25	30.6
	400	0.20	32.0
	500	0.12	30.0
	630	0.12	47.6

10.2 Temperature compensation coefficient table

Air temperature		-40°C	-35°C	-25°C	-15°C	-5°C	-0°C	10°C	20°C	30°C	40°C	50°C	60°C	70°C	
NM8N-250HV	Rated current (A)	63	88	86.5	83	80	77	75	72	69	66	63	58.5	53	46
		80	112	110	106	102	98	96	92	88	84	80	74.5	67	56
		100	140	137	132	127	122	120	115	110	105	100	93	84	80
		125	175	172	165	159	153	150	144	137	131	125	118	106	96
		160	224	220	212	204	196	192	184	176	168	160	152	136	120
		180	252	247	238	229	220	216	207	198	189	180	171	157	144
		200	280	275	265	255	245	240	230	220	210	200	190	175	166
		225	315	309	300	288	276	270	259	247	236	225	213	196	180
		250	350	343	332	319	306	300	287	275	262	250	237	218	207
NM8N-400HV/630HV		250	350	343	332	319	306	300	287	275	262	250	237	225	212
		315	441	433	418	402	386	378	362	346	331	315	300	286	271
		350	490	481	465	447	429	420	402	385	367	350	332	295	276
		400	560	550	530	510	490	480	460	440	420	400	380	360	320
		500	700	687	662	637	612	600	575	550	525	500	450	406	360
		630	882	865	834	802	770	756	725	693	661	630	567	511	454

10.3 Altitude derating coefficient table

Altitude (m)		2000m	3000m	4000m	5000m
Rated current (A)		1×In	0.96×In	0.93×In	0.9×In
Rated voltage Ue (V)		1150	1030	950	850
Rated Insulation voltage Ui (V)		1250	1120	1000	880
Dielectric properties (V)		2550	2300	2050	1800
Rated impulse withstand voltage	NM8N-250HV	8	8	8	8
	NM8N-400HV	12	10	8	8
	NM8N-630HV				

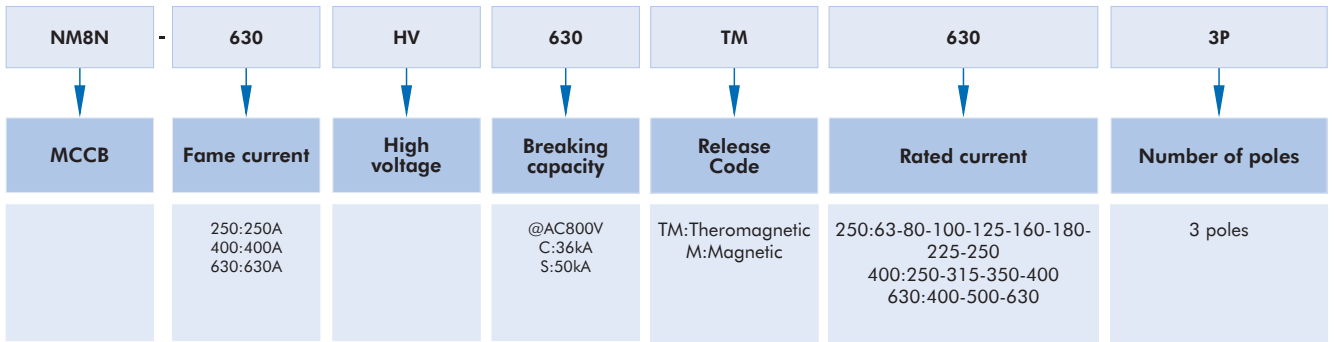

Diagram	In	Icu@800v	Ics@800v	Description	Order code
NM8N-HV	100A	36kA	36kA	NM8N-250HVC TM 100 3P	367764
	125A	36kA	36kA	NM8N-250HVC TM 125 3P	367765
	160A	36kA	36kA	NM8N-250HVC TM 160 3P	367766
	180A	36kA	36kA	NM8N-250HVC TM 180 3P	367768
	200A	36kA	36kA	NM8N-250HVC TM 200 3P	367769
	225A	36kA	36kA	NM8N-250HVC TM 225 3P	367767
	250A	36kA	36kA	NM8N-250HVC TM 250 3P	367770
	63A	36kA	36kA	NM8N-250HVC TM 63 3P	367762
	80A	36kA	36kA	NM8N-250HVC TM 80 3P	367763
	100A	50kA	50kA	NM8N-250HVS TM 100 3P	367772
	125A	50kA	50kA	NM8N-250HVS TM 125 3P	367775
	160A	50kA	50kA	NM8N-250HVS TM 160 3P	367777
	180A	50kA	50kA	NM8N-250HVS TM 180 3P	367776
	200A	50kA	50kA	NM8N-250HVS TM 200 3P	367774
	225A	50kA	50kA	NM8N-250HVS TM 225 3P	367778
	250A	50kA	50kA	NM8N-250HVS TM 250 3P	367779
	63A	50kA	50kA	NM8N-250HVS TM 63 3P	367771
	80A	50kA	50kA	NM8N-250HVS TM 80 3P	367773
	250A	36kA	36kA	NM8N-400HVC TM 250 3P	367780
	315A	36kA	36kA	NM8N-400HVC TM 315 3P	367781
	350A	36kA	36kA	NM8N-400HVC TM 350 3P	367784
	400A	36kA	36kA	NM8N-400HVC TM 400 3P	367783
	250A	50kA	50kA	NM8N-400HVS TM 250 3P	367782
	315A	50kA	50kA	NM8N-400HVS TM 315 3P	367785
	350A	50kA	50kA	NM8N-400HVS TM 350 3P	367786
	400A	50kA	50kA	NM8N-400HVS TM 400 3P	367787
	400A	36kA	36kA	NM8N-630HVC TM 400 3P	367789
	500A	36kA	36kA	NM8N-630HVC TM 500 3P	367788
	630A	36kA	36kA	NM8N-630HVC TM 630 3P	367790
	400A	50kA	50kA	NM8N-630HVS TM 400 3P	367791
500A	50kA	50kA	NM8N-630HVS TM 500 3P	367792	
630A	50kA	50kA	NM8N-630HVS TM 630 3P	367793	

No	category	Picture	Frame Size	voltage	discription	ordering code			
1	Auxiliary		ALL		AX21-M8	265343			
2	Alarm		ALL		AL21-M8	265345			
3	Front connection plate		125		FCP21-M8 1P	269702			
					FCP21-M8 2P	269703			
					FCP21-M8 3P	269704			
					FCP21-M8 4P	269705			
			250		FCP22-M8 1P	269706			
					FCP22-M8 2P	269707			
					FCP22-M8 3P	269708			
			400/630		FCP22-M8 4P	269709			
					FCP23-M8 3P	269710			
			FCP23-M8 4P	269711					
4	Undervoltage Release		250	AC110V	SHT22-M8NHV AC110V	434035			
				AC220-240V	SHT22-M8NHV AC220-240V	434034			
				AC380-415V	SHT22-M8NHV AC380-415V	434033			
				DC110-120V	SHT22-M8NHV DC110-120V	434037			
				DC220V	SHT22-M8NHV DC220V	434036			
				DC24V	SHT22-M8NHV DC24V	434038			
				400/630	AC110V	SHT23-M8NHV AC110V	528985		
			AC220-240V		SHT23-M8NHV AC220-240V	528986			
			AC380-415V		SHT23-M8NHV AC380-415V	528987			
			DC110-120V		SHT23-M8NHV DC110V-120V	528988			
			DC220V		SHT23-M8NHV DC220V	528989			
			DC24V		SHT23-M8NHV DC24V	528990			
			5		Extended Rotary Handle		250	AC110V	UVT22-M8NHV AC110V
				AC220-240V				UVT22-M8NHV AC220-240V	434040
AC380-415V	UVT22-M8NHV AC380-415V	434039							
DC110-120V	UVT22-M8NHV DC110-120V	434043							
DC220V	UVT22-M8NHV DC220V	434042							
DC24V	UVT22-M8NHV DC24V	434044							
400/630	AC110V	UVT23-M8NHV AC110V		528991					
	AC220-240V	UVT23-M8NHV AC220-240V		528992					
	AC380-415V	UVT23-M8NHV AC380-415V		528993					
	DC110-120V	UVT23-M8NHV DC110-120V		528994					
	DC220V	UVT23-M8NHV DC220V		528995					
	DC24V	UVT23-M8NHV DC24V		528996					
	6	Extended Rotary Handle					250/400		CRH22-M8NHV 3P
630								CRH23-M8NHV 3P	406595
7	Extended Handle		630		LHD23-M8NHV	434434			
8	Motor Operator		250	AC110/DC110-120V	MOD22-M8NHV AC110/DC110-120V	480096			
				AC220-240V/ DC220V	MOD22-M8NHV AC220-240V/DC220V	480097			
				AC380-415V	MOD22-M8NHV AC380-415V	480098			
				DC24V	MOD22-M8NHV DC24V	480099			
			400/630	AC110/DC110-120V	MOD23-M8NHV AC110/DC110-120V	475983			
				AC220-240V/ DC220V	MOD23-M8NHV AC220-240V/DC220V	475984			
				AC380-415V	MOD23-M8NHV AC380-415V	475985			
				DC24V	MOD23-M8NHV DC24V	475986			