

MANUAL MOTOR STARTERS

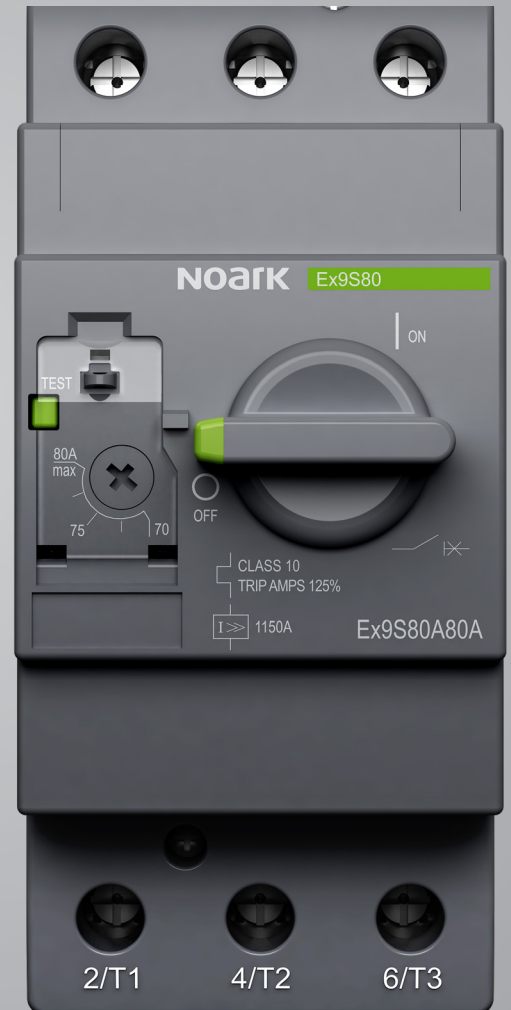

Ex9S

Manual Motor Starters

Ex9S Product Overview

Features

Ex9S Manual Motor Starter provide manual isolation, manual motor control, and overcurrent protection. Ex9S Manual Motor Starters are electro-mechanical devices combining the functions below in one unit.

- Disconnect for Motor Branch Circuit
- Manual Motor Control (automatic when used with contactor)
- Branch-Circuit Short Circuit Protection (Magnetic Protection)
- Overload Protection (Thermal Protection) - Trip Class 10
- 5-year limited warranty

The National Electrical Codes requires an individual Motor Branch Circuit to be protected by a UL/CSA Listed Fuse, Circuit breaker or Self-Protected Combination Motor Controller.

Available as:

- Up to 80A @600Vac
- UL 60947-4-1 Type E Self Protection-Ex9S32 and Ex9S80
- UL 60947-4-1 Type F Group Motor Protection-Ex9S80
- Built-in fault indication
- Full range of accessories
- Lockable handle

Manual Motor Starters

NOARK Ex9S Series

Certifications

- UL listed
- CCC Certified
- NOM Certified
- RoHs Compliant



Standards Compliance

- IEC/EN 60947-1, -2, -4-1, -5-1
- UL 60947-1; -4-1
- GB 14048.1, 2, 4
- CSA 22.2 NO. 60947-1,-4-1

Manual Motor Starters

Ex9S Product Selection

Label

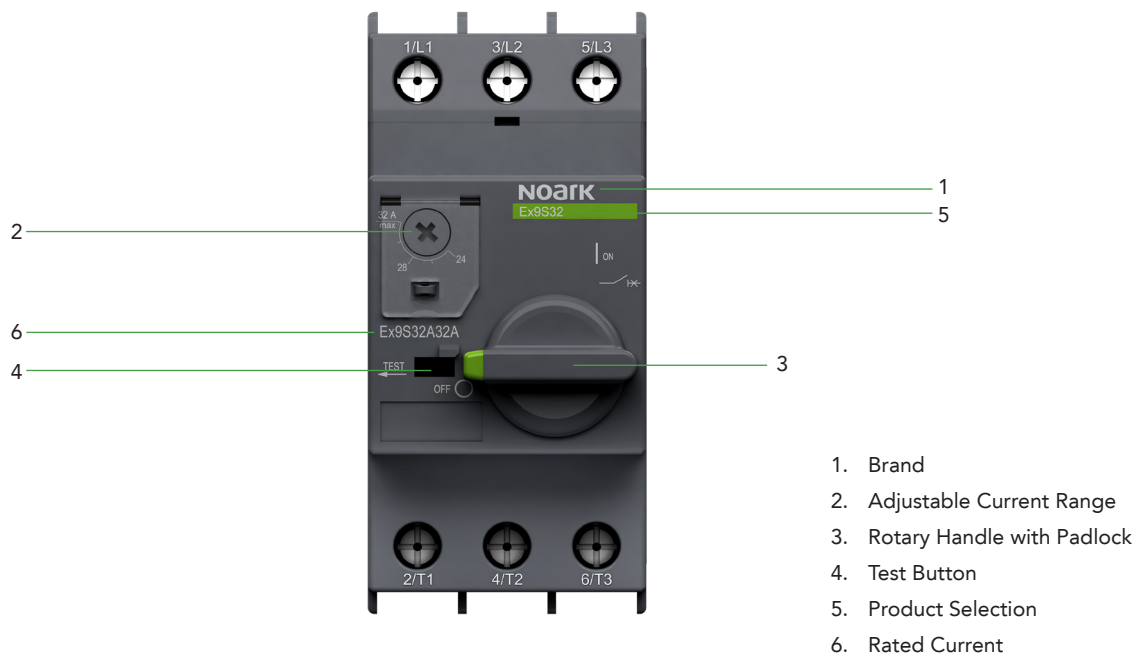

Product Selection Guide

Ex9S	32	A	25	A	M
NOARK Manual Motor Starter	Frame Sizes	Operation Type	Setting Current	Instantaneous Magnetic Trip Type	Protection Type
Ex9S	32: Up to 32A 80: Up to 80A	A: Rotary Operation B: Pushbutton Operation	* 0.16: 0.1-0.16A 0.25: 0.16-0.25A 0.4: 0.25-0.4A 0.63: 0.4-0.63A 1: 0.63-1A 1.6: 1-1.6A 2.5: 1.6-2.5A 4: 2.5-4A 6.3: 4-6.3A 10: 6-10A 14: 9-14A 18: 13-18A 23: 17-23A 25: 20-25A 32: 24-32A ** 20: 14-20A 25: 18-25A 32: 23-32A 40: 30-40A 50: 38-50A 63: 48-63A 72: 60-72A 80: 70-80A	A : Low **B: High	Blank: Thermal-Magnetic **M: Magnetic

* Applied for Ex9S32
** Applied for Ex9S80

Manual Motor Starters Ex9S Specifications



32 A



80 A

Certifications
IEC/EN 60947-4-1

Rated Current Amp (Min-Max)	Thermal Magnetic protection	
	Product	Part Number
0.10~0.16	Ex9S32A0.16A	1600046
0.16~0.25	Ex9S32A0.25A	1600047
0.25~0.40	Ex9S32A0.4A	1600048
0.40~0.63	Ex9S32A0.63A	1600049
0.63~1	Ex9S32A1A	1600050
1~1.6	Ex9S32A1.6A	1600051
1.6~2.5	Ex9S32A2.5A	1600052
2.5~4	Ex9S32A4A	1600053
Rated Current Amp (Min-Max)	Thermal Magnetic protection	
	Product	Part Number
4~6.3	Ex9S32A6.3A	1600054
6~10	Ex9S32A10A	1600055
9~14	Ex9S32A14A	1600056
13~18	Ex9S32A18A	1600057
17~23	Ex9S32A23A	1600058
20~25	Ex9S32A25A	1600059
24~32	Ex9S32A32A	1600060

Rated Current Amp (Min-Max)	Thermal Magnetic protection	
	Product	Part Number
14~20	Ex9S80A20A	1600170
18~25	Ex9S80A25A	1600171
23~32	Ex9S80A32A	1600172
30~40	Ex9S80A40A	1600173
38~50	Ex9S80A50A	1600174
48~63	Ex9S80A63A	1600175
60~72	Ex9S80A72A	1600176
70~80	Ex9S80A80A	1600177
Rated Current Amp (Min-Max)	Magnetic protection	
	Product	Part Number
14~20	Ex9S80A20AM	1600185
18~25	Ex9S80A25AM	1600186
23~32	Ex9S80A32AM	1600187
30~40	Ex9S80A40AM	1600188
38~50	Ex9S80A50AM	1600189
48~63	Ex9S80A63AM	1600190
60~72	Ex9S80A72AM	1600191
70~80	Ex9S80A80AM	1600192
Rated Current Amp (Min-Max)	Thermal Magnetic protection	
	Product	Part Number
14~20	Ex9S80A20B	1600178
18~25	Ex9S80A25B	1600179
23~32	Ex9S80A32B	1600180
30~40	Ex9S80A40B	1600181
38~50	Ex9S80A50B	1600182
48~63	Ex9S80A63B	1600183
60~72	Ex9S80A72B	1600184
Rated Current Amp (Min-Max)	Magnetic protection	
	Product	Part Number
14~20	Ex9S80A20BM	1600193
18~25	Ex9S80A25BM	1600194
23~32	Ex9S80A32BM	1600195
30~40	Ex9S80A40BM	1600196
38~50	Ex9S80A50BM	1600197
48~63	Ex9S80A63BM	1600198
60~72	Ex9S80A72BM	1600199

Manual Motor Starters

Ex9S Specifications

Technical Data

Description		Ex9S32	Ex9S80
Rated operational current I _e (A)		32A	80A
Conventional rated thermal current I _{th} (A)		0.16~32A	14-80A
Tripping Class		10	
Rated insulation voltage U _i (Vac)		690/IEC; 600/UL, CSA	
Rated operational voltage U _e (AC)		230/240, 400/415, 460/480, 575/600	
Rated impulse withstand voltage U _{imp} (AC)		6000V	
Rated Operational Frequency (Hz)		50/60Hz	
Resistance to shock		30 gn -11 ms	
Resistance to vibrations		5gn (5 -150Hz)	
Environmental Temperature	Transportation or Storage	-40°F to 176°F (-40°C to 80°C) ¹	
	Working at	-4°F to 140°F (-20°C to 60°C) ²	
	Testing at	59°F to 77°F (15°C to 25°C)	
	Instantaneous limit	-31°F to 158°F (-35°C to 70°C)	
Altitude ft (m)		Not to exceed 6,562 (2,000)	
Ambient Conditions		At mounting site, relative humidity not exceed 90% at the max testing temperature 104°F (40°C), higher relative humidity is allowable under lower temperature	
Pollution Grade		III	
Mounting Conditions		The inclination between the mounting plane and the vertical plane shall not exceed 30°; The product shall be installed and operated at a place without obvious shake, impact and vibration.	
Service life* (cycles)	Electrical	50000	50,000(Ex9S80, up to 63A) ;30,000(Ex9S80 72A&80A)
	Mechanical	100,000	50,000(Ex9S80, up to 72A) ;30,000(Ex9S80 80A)
Duty Class (cycles/hr)		30, max. operating rate	
Degree of Protection		IP 20	

1: 24 hours max. at the ultimated temperature

2: with temperature reduction factor

*: close/open operation, and 30 cycles/hr for AC-3 Duty@400/415Vac



Manual Motor Starters

Ex9S Specifications

Overload Protection Properties

Series Number	Multiple of Setting Current	Initial Status	Time	Expected Results	Ambient Temperature
1	1.05	Cold Status	$t \geq 2h$	Non-Tripping	68°F to ±35.6°F (+20°C to ±2°C)
2	1.25	Heat Status (right after test 1)	$t < 2h$	Tripping	
3	1.50		$t < 4 \text{ min}$		
4	7.20	Cold Status	$4s < t \leq 10s$		

Phase Failure Protection Properties

Series Number	Multiple of Setting Current		Initial Status	Time	Expected Results	Ambient Temperature
	Any 2 Phase	The Other Phase				
1	1.0	0.9	Cold Status	$t \geq 2h$	Non-Tripping	68°F to ±35.6°F (+20°C to ±2°C)
2	1.15	0	Heat Status (right after test 1)	$t < 2h$	Tripping	

Temperature Compensation Properties

Series Number	Multiple of Setting Current	Initial Status	Time	Expected Results	Ambient Temperature
1	1.0	Cold Status	$t \geq 2h$	Non-Tripping	104°F to ±35.6°F (+40°C to ±2°C)
2	1.25	Heat Status (right after test 1)	$t < 2h$	Tripping	
3	1.05	Cold Status	$t \geq 2h$	Non-Tripping	-23°F to ±35.6°F (-5°C to ±2°C)
4	1.3	Heat Status (right after test 1)	$t < 2h$	Tripping	

Manual Motor Starters

Ex9S Specifications

Motor Load Power For IEC

Manual self-protected starter	Overload Trip Range	Standard rated power of three-phase motor (kW) AC-3,50Hz/60Hz			
		230/240Vac	400/415Vac	500Vac	690Vac
Ex9S32A0.16A	0.1 - 0.16A	-	-	0.06	0.06
Ex9S32A0.25A	0.16- 0.25A	-	0.06	0.09	0.12
Ex9S32A0.4A	0.25 - 4A	0.06	0.09	0.12	0.18
Ex9S32A0.63A	0.4 - 0.63A	0.09	0.18	0.18	0.25
Ex9S32A1A	0.63 - 1A	0.18	0.25	0.37	0.55
Ex9S32A1.6A	1 - 1.6A	0.25	0.55	0.75	1.1
Ex9S32A2.5A	1.6 - 2.5A	0.37	0.75	1.1	1.5
Ex9S32A4A	2.5 - 4A	0.75	1.5	2.2	3
Ex9S32A6.3A	4 - 6.3A	1.5	2.2	3	4
Ex9S32A10A	6 - 10A	2.2	4	5.5	7.5
Ex9S32A14A	9 - 14A	3	5.5	7.5	11
Ex9S32A18A	13 - 18A	4	7.5	11	15
Ex9S32A23A	17 - 23A	5.5	11	15	18.5
Ex9S32A25A	20 - 25A	5.5	11	15	22
Ex9S32A32A	24 - 32A	7.5	15	18.5	22
Ex9S80A20A/B(M)	14- 20A	4	7.5	11	15
Ex9S80A25A/B(M)	18- 25A	5.5	11	15	22
Ex9S80A32A/B(M)	23- 32A	7.5	15	18.5	30
Ex9S80A40A/B(M)	30- 40A	11	18.5	22	37
Ex9S80A50A/B(M)	38- 50A	11	22	30	45
Ex9S80A63A/B(M)	48- 63A	15	30	37	55
Ex9S80A72A/B(M)	60- 72A	18.5	37	45	65
Ex9S80A80A(M)	70- 80A	22	45	50	70

Manual Motor Starters

Ex9S Specifications

Interrupting Capacity For IEC

Manual self-protected starter	Overload Trip Range	400 Vac				690 Vac			
		I _{cu} (kA)	I _{cs} (kA)	FUSE		I _{cu} (kA)	I _{cs} (kA)	FUSE	
				aM	gI/gG			aM	gI/gG
Ex9S32A0.16A	0.1 - 0.16A	100	100	-	-	100	100	-	-
Ex9S32A0.25A	0.16- 0.25A	100	100	-	-	100	100	-	-
Ex9S32A0.4A	0.25 - 4A	100	100	-	-	100	100	-	-
Ex9S32A0.63A	0.4 - 0.63A	100	100	-	-	100	100	-	-
Ex9S32A1A	0.63 - 1A	100	100	-	-	100	100	-	-
Ex9S32A1.6A	1 - 1.6A	100	100	-	-	100	100	-	-
Ex9S32A2.5A	1.6 - 2.5A	100	100	-	-	100	100	-	-
Ex9S32A4A	2.5 - 4A	100	100	-	-	6	4	25	32
Ex9S32A6.3A	4 - 6.3A	100	100	-	-	6	4	32	40
Ex9S32A10A	6 - 10A	100	100	-	-	6	4	32	40
Ex9S32A14A	9 - 14A	100	100	-	-	6	4	40	50
Ex9S32A18A	13 - 18A	50	30	63	80	6	4	40	50
Ex9S32A23A	17 - 23A	50	30	80	100	6	4	40	50
Ex9S32A25A	20 - 25A	50	30	80	100	6	4	40	50
Ex9S32A32A	24 - 32A	50	30	100	125	6	4	50	63
Ex9S80A20A/B(M)	14- 20A	100	100	-	-	8	8	50	63
Ex9S80A25A/B(M)	18- 25A	100	100	-	-	8	8	50	63
Ex9S80A32A/B(M)	23- 32A	100	100	-	-	8	8	50	63
Ex9S80A40A/B(M)	30- 40A	50	50	125	160	8	8	63	80
Ex9S80A50A/B(M)	38- 50A	50	50	125	160	8	8	63	80
Ex9S80A63A/B(M)	48- 63A	50	50	125	160	8	8	80	100
Ex9S80A72A/B(M)	60- 72A	50	50	160	200	8	8	100	125
Ex9S80A80A(M)	70- 80A	50	50	160	200	8	8	100	125

Manual Motor Starters

Ex9S Specifications

Motor Load Power For UL

Manual self-protected starter	Overload Trip Range	UL motor load power						
		1PH		200Vac			3PH	
		110-120Vac	220-240Vac	200Vac	208Vac	220-240Vac	460-480Vac	575-600Vac
Ex9S32A0.16A	0.1 - 0.16A	-	-	-	-	-	-	-
Ex9S32A0.25A	0.16- 0.25A	-	-	-	-	-	-	-
Ex9S32A0.4A	0.25 - 4A	-	-	-	-	-	-	-
Ex9S32A0.63A	0.4 - 0.63A	-	-	-	-	-	-	-
Ex9S32A1A	0.63 - 1A	-	-	-	-	-	-	0.5
Ex9S32A1.6A	1 - 1.6A	-	0.1	-	-	-	0.75	0.75
Ex9S32A2.5A	1.6 - 2.5A	-	0.167	0.5	0.5	0.5	1	1.5
Ex9S32A4A	2.5 - 4A	0.125	0.333	0.75	0.75	0.75	2	3
Ex9S32A6.3A	4 - 6.3A	0.25	0.5	1	1	1.5	3	5
Ex9S32A10A	6 - 10A	0.5	1.5	2	2	3	5	7.5
Ex9S32A14A	9 - 14A	0.75	2	3	3	3	10	10
Ex9S32A18A	13 - 18A	1	3	5	5	5	10	15*
Ex9S32A23A	17 - 23A	1.5	3	5	-	7.5	15	20*
Ex9S32A25A	20 - 25A	2	-	-	-	7.5	15	20*
Ex9S32A32A	24 - 32A	2	5	7.5	7.5	10	20	25*
Ex9S80A20A/B(M)	14- 20A	1	3	5	5	5	10	15
Ex9S80A25A/B(M)	18- 25A	2	-	-	7.5	7.5	15	20
Ex9S80A32A/B(M)	23- 32A	2	5	7.5	7.5	10	20	25
Ex9S80A40A/B(M)	30- 40A	3	-	10	10	-	25	30
Ex9S80A50A/B(M)	38- 50A	-	-	15	15	15	30	40
Ex9S80A63A/B(M)	48- 63A	5	10	15	20	20	40	50
Ex9S80A72A/B(M)	60- 72A	-	-	20	-	25	50	60
Ex9S80A80A(M)	70- 80A	-	-	25	25	-	60	75

* Manual Motor Control and Motor Disconnect only, not applied in Combination Motor Control.



Manual Motor Starters

Ex9S Specifications

Short-Circuit Current Rating



Type E: Self-Protected Combination Motor Controller

Manual self-protected starter	Overload Trip Range	Type E		Type E		Type E		Matching accessories
		SCCR (kA)	240Vac	SCCR (kA)	480Y/277Vac	SCCR (kA)	600Y/347Vac	
Ex9S32A0.16A	0.1 - 0.16A		65			10		CCE51, AL5111
Ex9S32A0.25A	0.16 - 0.25A		65			10		
Ex9S32A0.4A	0.25 - 0.4A		65			10		
Ex9S32A0.63A	0.4 - 0.63A		65			10		
Ex9S32A1A	0.63 - 1A		65			10		
Ex9S32A1.6A	1 - 1.6A		65			10		
Ex9S32A2.5A	1.6 - 2.5A		65			10		
Ex9S32A4A	2.5 - 4A		65			10		
Ex9S32A6.3A	4 - 6.3A		65			10		
Ex9S32A10A	6 - 10A		65			10		
Ex9S32A14A	9 - 14A		65			10		
Ex9S32A18A	13 - 18A		42			-		
Ex9S32A23A	17 - 23A		42			-		
Ex9S32A25A	20 - 25A		42			-		
Ex9S32A32A	24 - 32A		42			-		
Ex9S80A20A/B	14 - 20A		42			30		AL5111
Ex9S80A25A/B	18 - 25A		42			30		
Ex9S80A32A/B	23 - 32A		42			30		
Ex9S80A40A/B	30 - 40A		42			18		
Ex9S80A50A/B	38 - 50A		42			18		
Ex9S80A63A/B	48 - 63A		42			10		
Ex9S80A72A/B	60 - 72A		42			10		
Ex9S80A80A	70 - 80A		10			10		

Manual Motor Starters

Ex9S Specifications

Short-Circuit Current Rating Continued



Type F: Manual Self-Protected Combination Motor Controller

G

Manual Self-Protected Starter	Associated Cable, AWG 75°C, Cu	Type of Contactor Required	Overload Trip Range(A)	SCCR (kA)			Combination Block	Mounting Bracket
				240V	480Y/277V	600Y/347V		
Ex9S32A0.16A	14	Ex9CS06/09 Ex9C09	0.1-0.16	65	-	10	CC51/CC52	-/DRA51
Ex9S32A0.25A			0.16-0.25					
Ex9S32A0.4A			0.25-0.4					
Ex9S32A0.63A			0.4-.63					
Ex9S32A1A			0.63-1					
Ex9S32A1.6A			1-1.6					
Ex9S32A2.5A			1.6-2.5					
Ex9S32A4A			2.5-4					
Ex9S32A6.3A			4-6.3					
Ex9S32A10A			Ex9CS12/9C12					
Ex9S32A14A	12	Ex9C18	9-14	42	-	CC52	DRA51	
Ex9S32A18A		Ex9C25	13-18					
Ex9S32A23A	10	Ex9C38/32	17-23	42	-	CC53	DRA51	
Ex9S32A25A			20-25					
Ex9S32A32A	8	Ex9C38/32	24-32	42	-	CC53	DRA51	

Manual Motor Starters

Ex9S Specifications

Temperature Derating Factor

Device	-20°C ≤ T ≤ 0°C		0°C < T < 30°C		30°C ≤ T ≤ 40°C		40°C < T ≤ 60°C	
	single	group	single	group	single	group	single	group
Ex9S32A0.16A	1.05	1	1	1	1	1	1	0.98
Ex9S32A0.25A	1.05	1	1	1	1	0.99	0.98	0.97
Ex9S32A0.4A	1.05	1	1	1	1	0.96	0.96	0.93
Ex9S32A0.63A	1.05	1	1	1	1	0.97	0.96	0.94
Ex9S32A1A	1.05	1	1	1	1	0.96	0.96	0.91
Ex9S32A1.6A	1.05	1	1	1	1	0.96	0.96	0.93
Ex9S32A2.5A	1.05	1	1	1	1	1	1	0.99
Ex9S32A4A	1.05	1	1	0.98	1	0.98	0.98	0.96
Ex9S32A6.3A	1.05	1	1	0.97	1	0.96	0.96	0.95
Ex9S32A10A	1.05	1	1	0.96	1	0.94	0.94	0.91
Ex9S32A14A	1.05	1	1	0.96	1	0.94	0.94	0.90
Ex9S32A18A	1.05	1	1	0.96	1	0.93	0.92	0.90
Ex9S32A23A	1.05	1	1	0.95	1	0.94	0.93	0.90
Ex9S32A25A	1.05	1	1	0.95	1	0.94	0.93	0.90
Ex9S32A32A	1.05	1	1	0.92	1	0.91	0.91	0.87
Ex9S80A20A/B	1.05	1	1	1	1	0.98	1	0.96
Ex9S80A25A/B	1.05	1	1	1	1	0.98	1	0.96
Ex9S80A32A/B	1.05	1	1	1	1	0.98	1	0.96
Ex9S80A40A/B	1.05	1	1	0.98	1	0.98	1	0.96
Ex9S80A50A/B	1.05	1	1	0.97	1	0.96	0.96	0.93
Ex9S80A63A/B	1.05	1	1	0.95	1	0.93	0.92	0.9
Ex9S80A72A/B	1.05	1	1	0.95	1	0.93	0.93	0.9
Ex9S80A80A	1.05	1	1	0.94	1	0.9	0.9	0.88

* Please refer to derating table for multiple use of electromagnetic product or use single unit above 40°C

Manual Motor Starters Ex9S Specifications

Manual self-protected starter	Setting Current (A)		Magnetic Trip Rating (A)	
	Minimum	Maximum	A	B
Ex9S32A0.16A	0.1	0.16	2.1	-
Ex9S32A0.25A	0.16	0.25	3.2	-
Ex9S32A0.4A	0.25	4	4.8	-
Ex9S32A0.63A	0.4	0.63	7.2	-
Ex9S32A1A	0.63	1	11	-
Ex9S32A1.6A	1	1.6	20	-
Ex9S32A2.5A	1.6	2.5	30	-
Ex9S32A4A	2.5	4	50	-
Ex9S32A6.3A	4	6.3	72.5	-
Ex9S32A10A	6	10	130	-
Ex9S32A14A	9	14	175	-
Ex9S32A18A	13	18	230	-
Ex9S32A23A	17	23	280	-
Ex9S32A25A	20	25	322	-
Ex9S32A32A	24	32	416	-
Ex9S80A20A/B(M)	14	20	310	400
Ex9S80A25A/B(M)	18	25	375	500
Ex9S80A32A/B(M)	23	32	445	680
Ex9S80A40A/B(M)	30	40	560	800
Ex9S80A50A/B(M)	38	50	700	960
Ex9S80A63A/B(M)	48	63	950	1150
Ex9S80A72A/B(M)	60	72	1000	1150
Ex9S80A80A(M)	70	80	1150	-

Ex9S32 Trip Curve

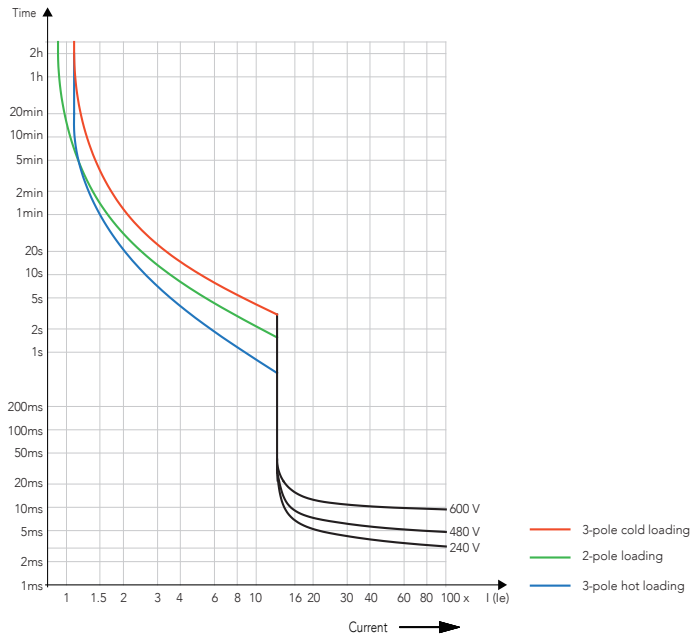

Ex9S80 Trip Curve

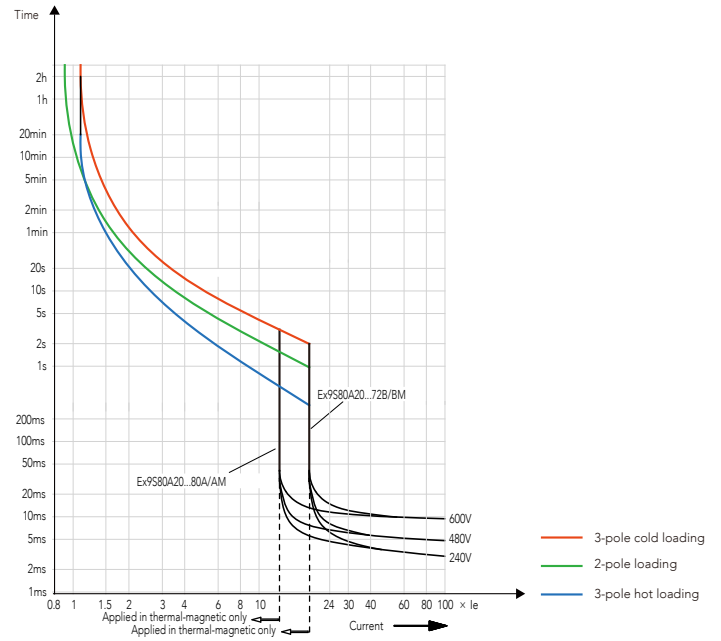

Manual Motor Starters

Ex9S Dimensions

Ex9S32
Unit: in. [mm]

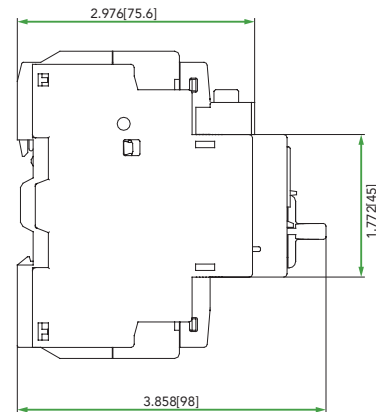
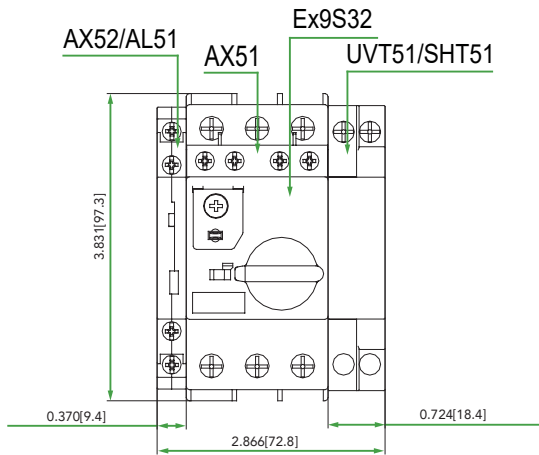
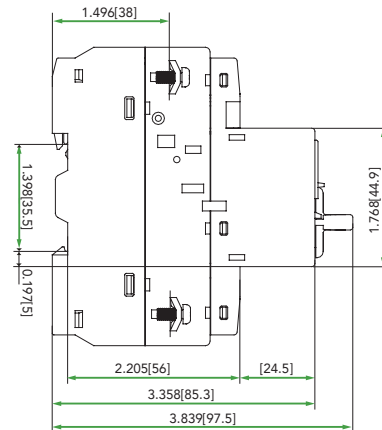
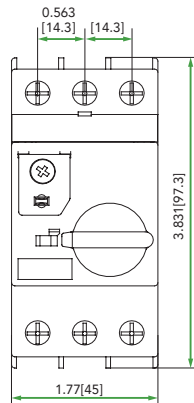

Ex9S32 + CCE51
Unit: in [mm]

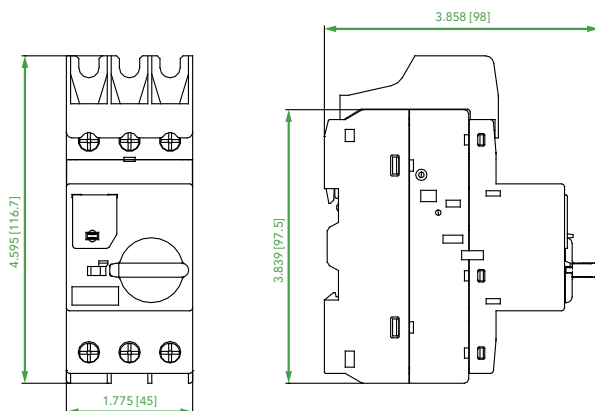

CCE51
Unit: in [mm]

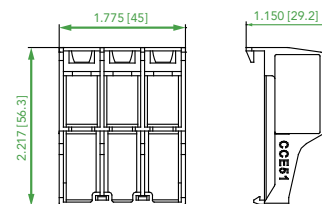

G

Manual Motor Starters Ex9S80 Dimensions

Ex9S80

Unit: in. [mm]

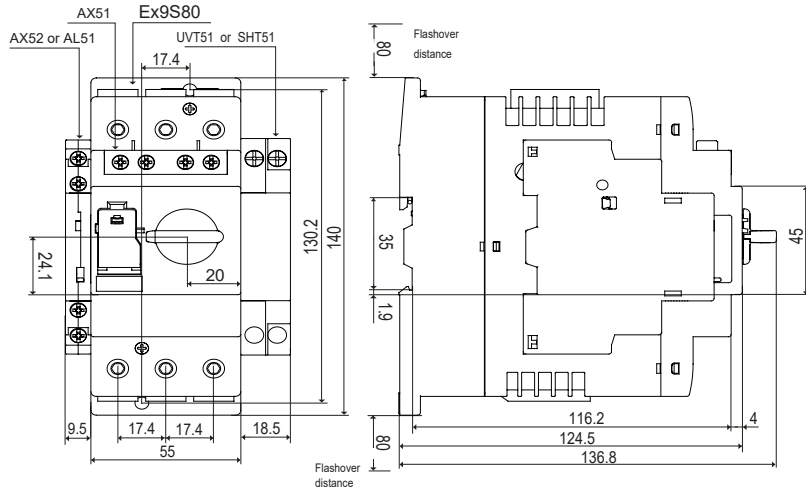

Manual Motor Starters

Ex9S Accessories Selection Guide

Selection

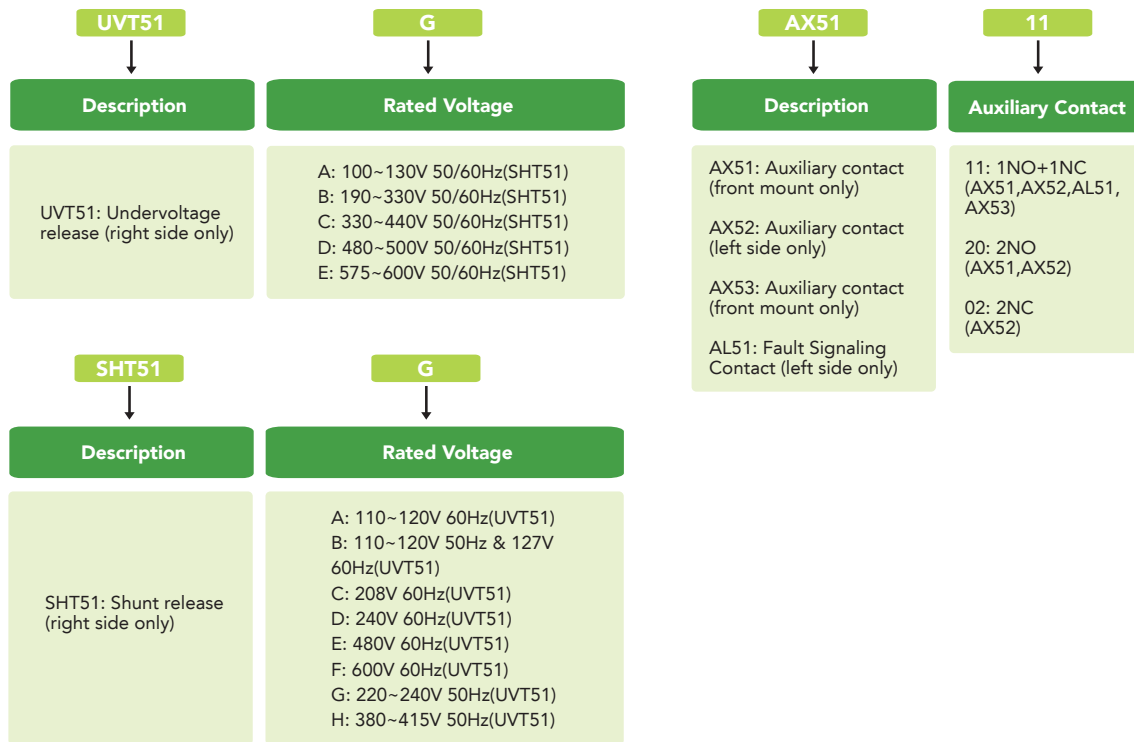

G

CC	51
Description	Type
Combination Block	51:Ex9CS 12A
	52: Ex9C09-18A
	53: Ex9C 25-38A

DRA	51
Description	Type
Mounting Bracket	51: for mounting Ex9S32 with Ex9C 09-38A

ERH	51	B
Description	Type	Color of Handle
Extended Rotary Handle	51: for Ex9S	B: Black/Gray
		Y: Yellow/Red

WPB	51	B
Description	Type	Color of Handle
Waterproof Enclosure	51: for Ex9S32	B: Black/Gray
		Y: Yellow/Red

Manual Motor Starters

Ex9S Accessories: Specifications

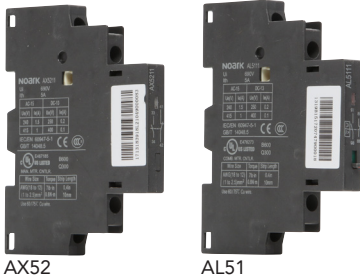

AX52

AL51



AX51

Auxiliary Contact Blocks

Description	Mounting Location	Max. No. of Blocks	Contact Type	SKU
Instantaneous auxiliary contacts	Front	1	NO+NC	AX5111
			NO+NO	AX5120
			NO+NC	AX5311
	Left Side	2	NO+NC	AX5211
			NO+NO	AX5220
Fault Signaling Contact		1	NC+NC	AX5202
			NO+NC	AL5111

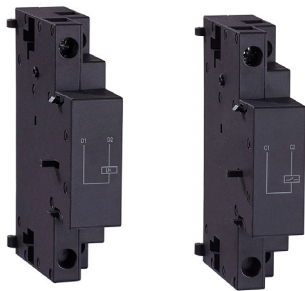

UVT51

SHT51

Electrical Trip Unit

Description	Mounting Location	Voltage	Hz	SKU
Undervoltage Release	Right Side	110-120V	60	UVT51A
		127V	60	UVT51B
		110-120V	50	UVT51B
		208V	60	UVT51C
		240V	60	UVT51D
		480V	60	UVT51E
		600V	60	UVT51F
		220-240V	50	UVT51G
		380-415V	50	UVT51H
Shunt Release	Right Side	100-130V	50/60	SHT51A
		190-330V	50/60	SHT51B
		330-440V	50/60	SHT51C
		480-500V	50/60	SHT51D
		575-600V	50/60	SHT51E

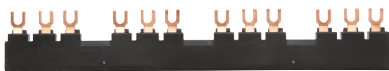

BBUM 454

Busbars

Description	No. of Ex9S32 Starter	No. of Side-Mounted Aux Contact on each Ex9S32 starter	Busbar Pitch (mm)	SKU
Sets of 3-pole, 63A Busbar	2	None	45	BBUM 245
		1 of AX52, AL51	54	BBUM 254
		2 of AX52 or 1 UVT51, SHT51	63	BBUM 263
	3	None	45	BBUM 345
		1 of AX52, AL51	54	BBUM 354
		2 of AX52 or 1 UVT51, SHT51	63	BBUM 363
	4	None	45	BBUM 445
		1 of AX52, AL51	54	BBUM 454
		2 of AX52 or 1 UVT51, SHT51	63	BBUM 463
	5	None	45	BBUM 545
		1 of AX52, AL51	54	BBUM 554
		2 of AX52 or 1 UVT51, SHT51	63	BBUM 563

Manual Motor Starters

Ex9S Accessories: Specifications



CCE51

Wiring Accessories

Description	Application	SKU
Input Terminal for CBB51 Busbar	Terminal block for power supply to one or more CBB51 bus bar	FD51
Protective end cover	For unused busbar outlets	PC51
Terminal Cover	Terminal cover for Ex9S32 for use in type E application	CCE51



WPB51B



WPB51Y

Enclosures

Description	Type	Color	Rating	SKU
Waterproof Enclosure; Ex9S32 Protectors	Operation by rotary handle	Black/ Gray	NEMA 4X/4, IP 65	WPB51B
		Yellow/ Red		WPB51Y

Operation Handle



ERH51B

Description	Type	Color	Rating	SKU
Extended Rotary Handle	9 inch (230mm) shaft, with bracket	Black/ Gray	NEMA 4X/4, IP65	ERH51B
		Yellow/ Red		ERH51Y

The extended rotary handle makes it possible for a door-mounted rotary handle to operate starter installed on the inside back panel of an enclosure. The extended rotary handle consists of the following:

- a set of screws onto the handle of the starter
- an assembly (handle and front plate) that fits on the enclosure door
- an extension shaft which must be adjusted according to the distance between the mounting surface and the door: 9 inch (230 mm)
- a bracket that install with starter and the shaft through



DRA51

Mounting Accessories

Description	Application	SKU
Combination Block	Between Ex9S32 and Ex9C Mini Type Contactor, 09-12A	CC51
	Between Ex9S32 and Ex9C Standard Type Contactor, 09-18A	CC52
	Between Ex9S32 and Ex9C Standard Type Contactor, 25-38A	CC53
Mounting Bracket	For mounting a Ex9S32 to a Ex9C Standard Type Contactor, 09-38A	DRA51

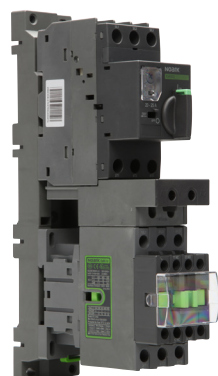

Ex9S32 + CC53 + Ex9C32 + DRA51

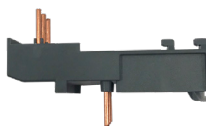

CC51

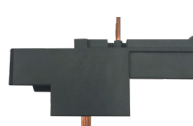

CC52

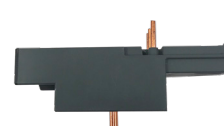

CC53

Manual Motor Starters

Ex9S Accessories: Specifications

Technical Data

	Auxiliary contacts AX51	Auxiliary contacts AX52	Auxiliary contacts AX53	Auxiliary contacts AX51
Rated operational voltage U_e	300V	600V	60VAC, 24VDC	600V
Rated frequency	50/60Hz	50/60Hz	-	50/60Hz
Rated impulse withstand voltage U_{imp}	2500V	6000V	800V	6000V
Conventional rated thermal current (I _{th})"	2.5A	5A	1A	5A
Mechanical life (C-O operations)	100000	100000	100000	100000
Electrical Rating	C300,Q300	B600,Q300	AC-12:60V/0.1A DC-12:24V/1A	B600,Q300
Minimum connection Load	5mA/24VAC, 24VDC	8mA/24VAC, 24VDC	2mA/12VAC, 12VDC or 3mA/5VDC	8mA/24VAC, 24VDC

Terminal Wiring

Screw Type	Ex9S32	Ex9S80
	M4, Phil-Slot head	M8, Phil-Hex head
Pull wire length inch (mm)	0.4 (10)	0.59 (15)
Wire range AWG	(1)x14-(2)x8	14-3
Torques lb-in (N.m)	22 (2.5)	53 (6)

Model	Wire Ranges(AWG)	Torques lb-in (N.m)	Screw Type
AX51	(1)x18-(2)x12	7 (0.8)	M3
AX52	(1)x18-(2)x12	7 (0.8)	M3
AX53	(1)x18-(2)x14	7 (0.8)	M3
AL51	(1)x18-(2)x12	7 (0.8)	M3
UVT51	(1)x18-(2)x12	15 (1.7)	M3.5
SHT51	(1)x18-(2)x12	15 (1.7)	M3.5

Phil-Slot Head

Electrical Diagram

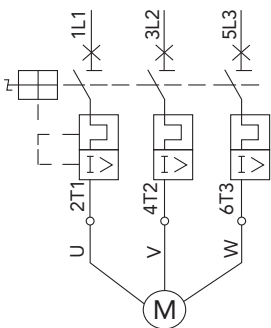

Operating principle diagram of starter

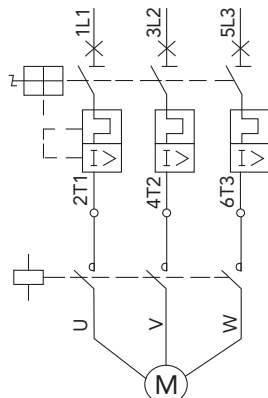

Principle connection diagram of starter and contactor

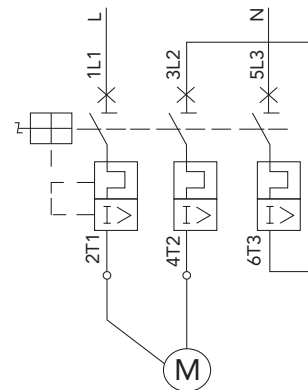

Principle connection diagram of single-phase Motor

Manual Motor Starters

Ex9S Accessory Dimensions

Ex9S32 + CC51 + Ex9CS06, 09, 12

Unit: in [mm]

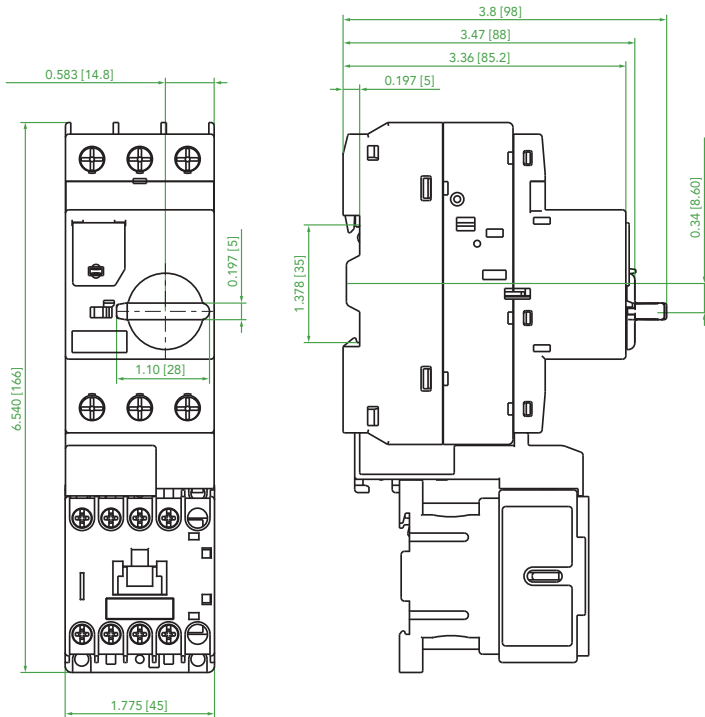

CC51

Unit: in [mm]

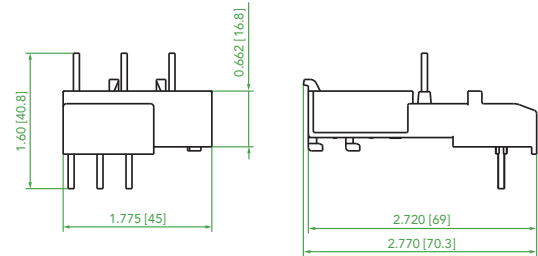

Ex9S32 + CC52 + Ex9C09, 12 18

Unit: in [mm]

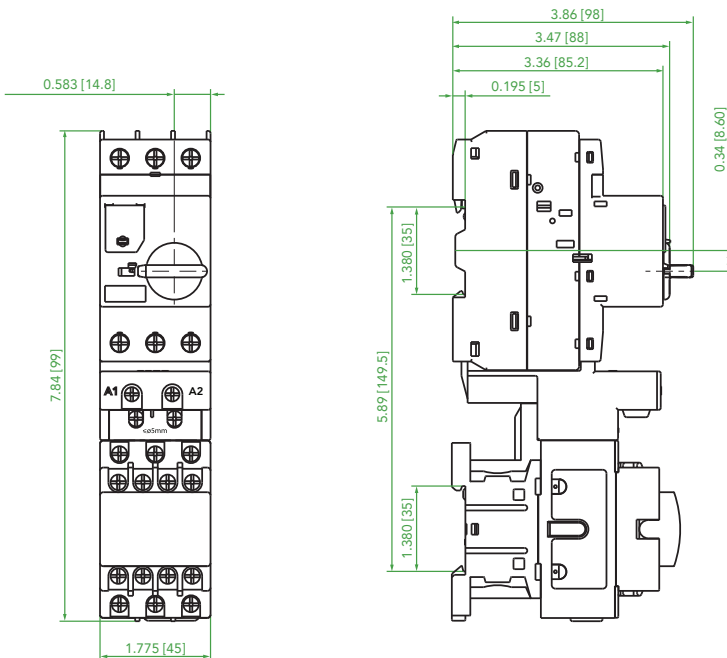

CC52

Unit: in [mm]

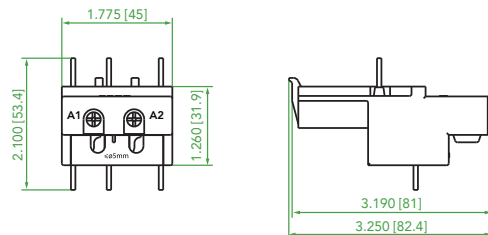

G

Manual Motor Starters

Ex9S Accessory Dimensions

Ex9S32 + CC52 + Ex9C09, 12, 18 + DRA51

Unit: in [mm]

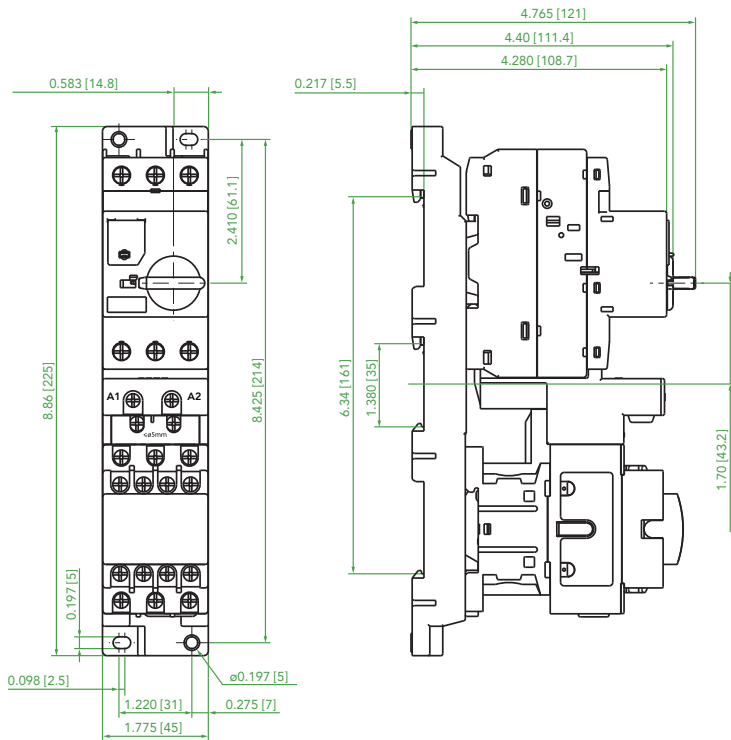

CC52

Unit: in [mm]

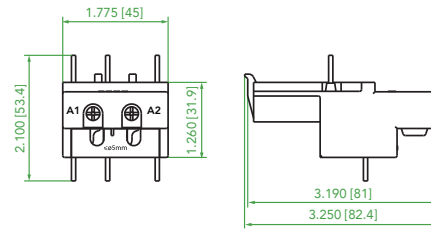

DRA51

Unit: in [mm]

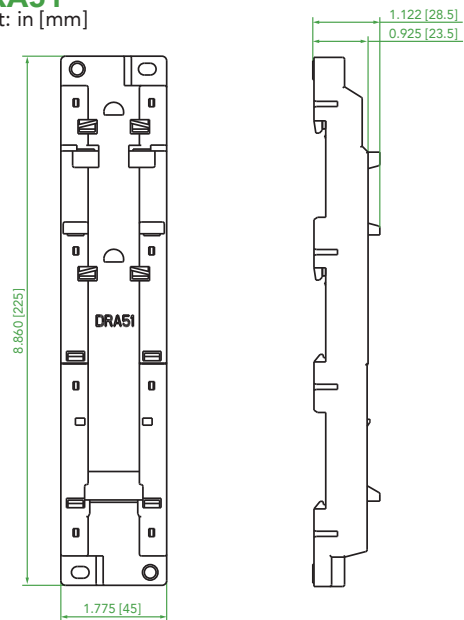

Ex9S32 + CC53 + Ex9C25, 32, 38

Unit: in [mm]

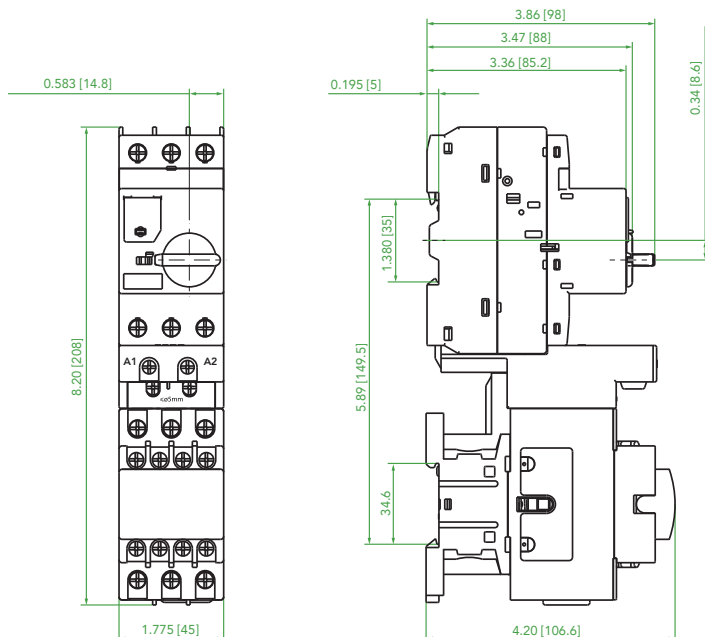

CC53

Unit: in [mm]

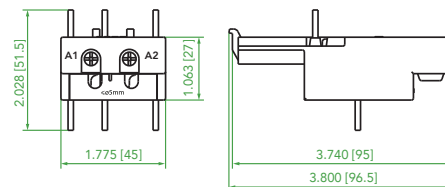

Manual Motor Starters Ex9S Accessory Dimensions

WPB51

Unit: in [mm]

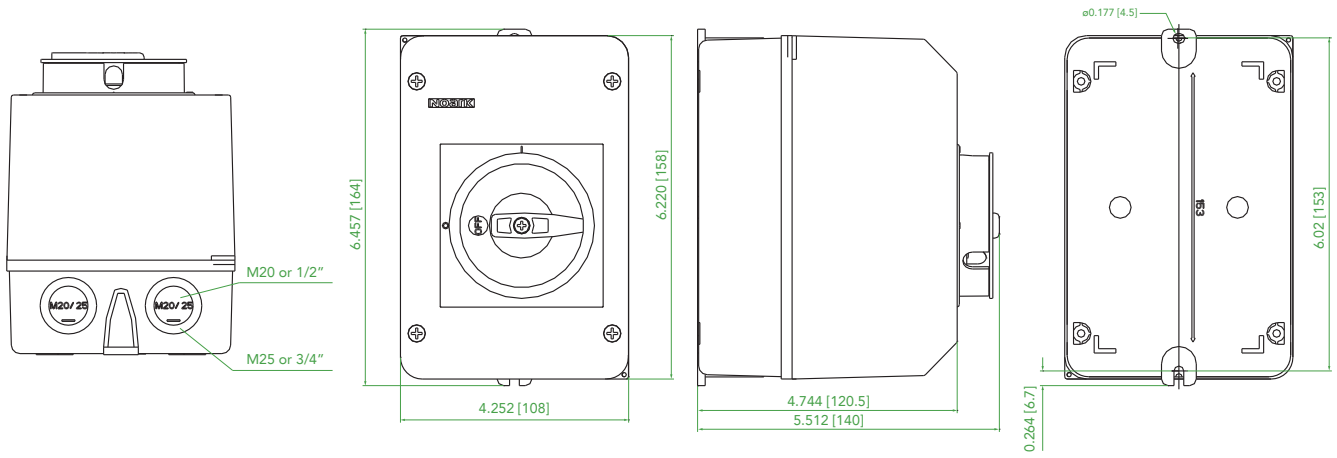

NOARK®

NOARK Electric North America
(626) 330-7007

na.noark-electric.com • nasales@noark-electric.com



Note: NOARK Electric reserves the right to make technical changes or modify the contents of this document without prior notice. With regard to purchase orders, the agreed particulars shall prevail. NOARK Electric does not accept any responsibility whatsoever for potential errors or possible lack of information in this document. NOARK Electric reserves all rights in this document and in the subject matter and illustrations contained therein. Any reproduction, disclosure to third parties or utilization of its contents – in whole or in parts – is forbidden without prior written consent of NOARK Electric.