

DEFINITE PURPOSE CONTACTORS

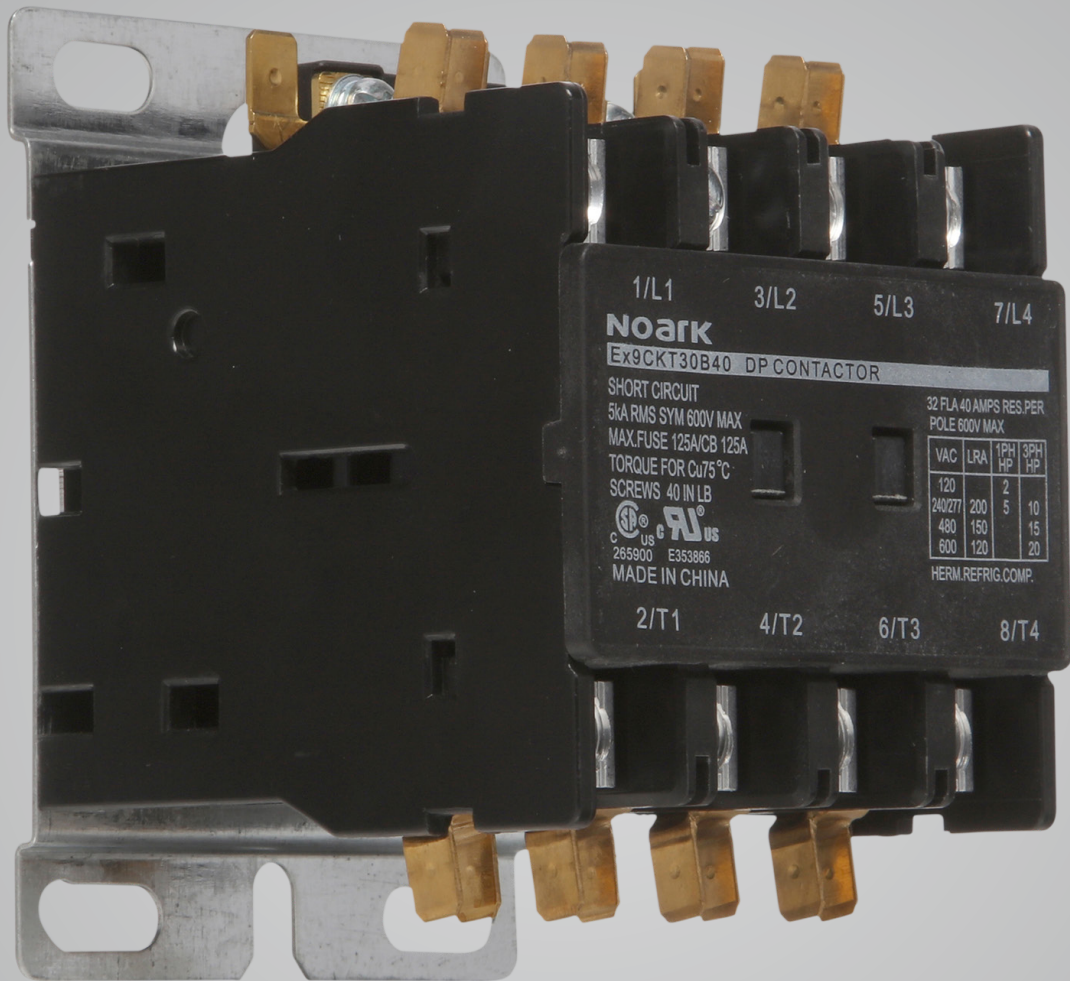

Ex9CKT

Definite Purpose Contactors

Ex9CKT Product Overview

Features

Ex9CKT Series DP Contactors provide high performance with both flexibility and reliability. They are designed to match numerous applications including:

- Air conditioning
- Resistive heating
- Refrigeration equipment
- Motors
- Welding
- Pumps
- Power supplies
- Food service equipment
- Compressors
- Business machines
- Lighting (25-50A)

Available as:

- 20~40A, 1 to 4 pole available now
- Enclosed coil standard for all 1 to 4 pole frame sizes
- Industry standard mounting plate provides easily accessible mounting holes
- Connection terminal options, including screw or lug connections each with quick connect spades
- Coil is Class B 266°F (130°C) insulation system with a wide range of voltages and 50/60 Hz ratings
- Double E magnet assembly provides optimal performance with reduced power consumption
- Base assembly is made from high arc-resistant polyester
- 100,000 to 250,000 cycles by UL 508/UL60947-4-1 for air resistance heating application

Definite Purpose Contactors

NOARK Ex9CKT Series

Certifications

- UL 60947-1; UL 60947-4-1; UL 508; UL E353866
- CSA Certified, C22.2 No. 265900
- IEC/EN 60947-4-1 Compliant
- CE Approved
- Compliance to ARI-780 HVAC standards



Definite Purpose Contactors

Ex9CKT Product Selection Guide

Label

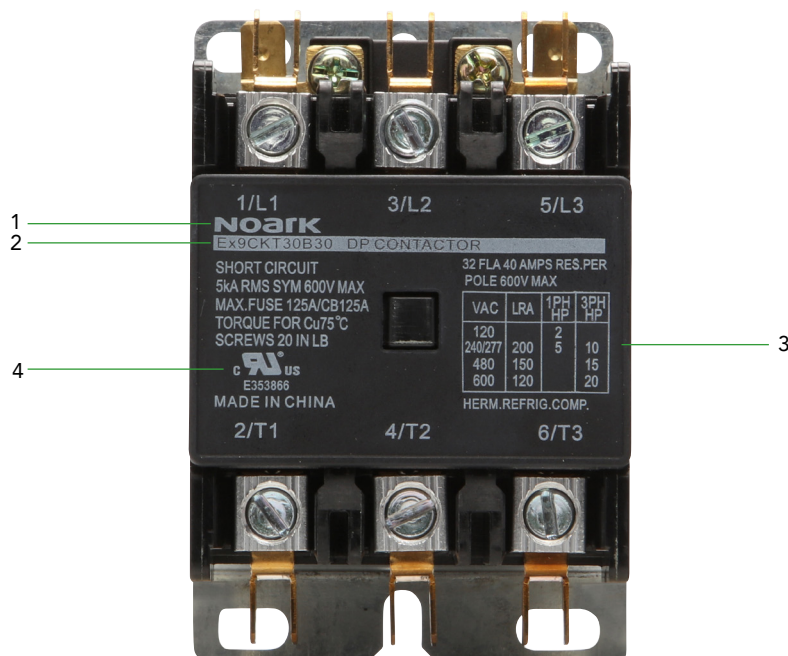

1. Brand
2. Product Selection
3. AC Coil Voltage
4. UL Recognized Component

Product Selection Guide

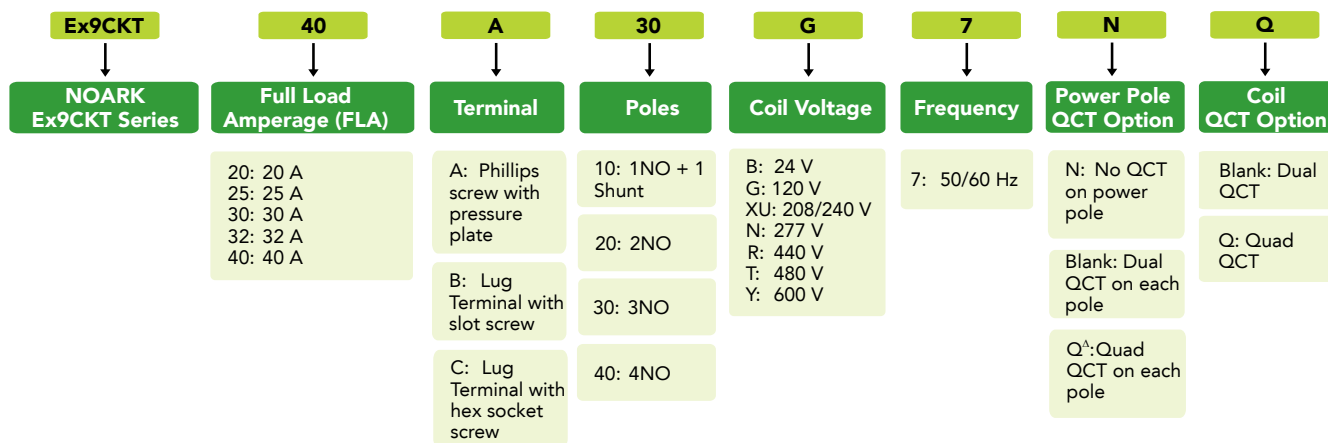

Δ 1 & 2 Pole only

NOARK Standard: L means coil mounted on top side; T means coil mounted on bottom side
Contact NOARK Sales for more configuration

Definite Purpose Contactors

Ex9CKT 20A



20A, Screw, 50/60Hz, Dual QCT

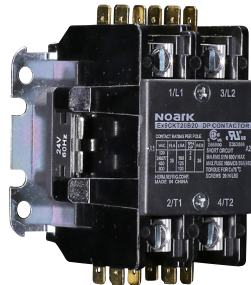

20A, Screw, 50/60Hz, Quad QCT

Certifications
IEC/EN 60947-4-1

Coil Voltage Vac	1 Pole 1NO+1Shunt		1 Pole 1NO+1Shunt	
	Product	Part Number	Product	Part Number
24	Ex9CKT20A10B7	1314177	Ex9CKT20A10B7Q	1314115
120	Ex9CKT20A10G7	1314178	Ex9CKT20A10G7Q	1314116
208-240	Ex9CKT20A10XU7	1314179	Ex9CKT20A10XU7Q	1314117
277	Ex9CKT20A10N7	1314180	Ex9CKT20A10N7Q	1314118
440	Ex9CKT20A10R7	1314181	Ex9CKT20A10R7Q	1314119
480	Ex9CKT20A10T7	1314182	Ex9CKT20A10T7Q	1314120
600	Ex9CKT20A10Y7	1313992	Ex9CKT20A10Y7Q	1314083

20A, Screw, 50/60Hz, Dual QCT

20A, Screw, 50/60Hz, Quad QCT

Coil Voltage Vac	2 Pole 2NO		2 Pole 2NO	
	Product	Part Number	Product	Part Number
24	Ex9CKT20A20B7	1314491	Ex9CKT20A20B7Q	1314431
120	Ex9CKT20A20G7	1314492	Ex9CKT20A20G7Q	1314432
208-240	Ex9CKT20A20XU7	1314493	Ex9CKT20A20XU7Q	1314433
277	Ex9CKT20A20N7	1314494	Ex9CKT20A20N7Q	1314434
440	Ex9CKT20A20R7	1314495	Ex9CKT20A20R7Q	1314435
480	Ex9CKT20A20T7	1314496	Ex9CKT20A20T7Q	1314436
600	Ex9CKT20A20Y7	1313997	Ex9CKT20A20Y7Q	1314623

20A, Screw, 50/60Hz, Dual QCT

20A, Screw, 50/60Hz, Dual QCT

Coil Voltage Vac	3 Pole 3NO		4 Pole 4NO	
	Product	Part Number	Product	Part Number
24	Ex9CKT20A30B7	1314312	Ex9CKT20A40B7	1314372
120	Ex9CKT20A30G7	1314313	Ex9CKT20A40G7	1314373
208-240	Ex9CKT20A30XU7	1314314	Ex9CKT20A40XU7	1314374
277	Ex9CKT20A30N7	1314315	Ex9CKT20A40N7	1314375
440	Ex9CKT20A30R7	1314316	Ex9CKT20A40R7	1314376
480	Ex9CKT20A30T7	1314317	Ex9CKT20A40T7	1314377
600	Ex9CKT20A30Y7	1314002	Ex9CKT20A40Y7	1314030

F

Definite Purpose Contactors

Ex9CKT 20A

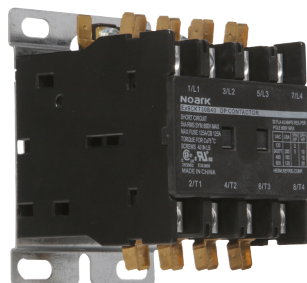

20A, Lug, 50/60Hz, Dual QCT 20A, Lug, 50/60Hz, Quad QCT

Coil Voltage Vac	1 Pole 1NO+1Shunt		1 Pole 1NO+1Shunt	
	Product	Part Number	Product	Part Number
24	Ex9CKT20B10B7	1314146	Ex9CKT20B10B7Q	1314085
120	Ex9CKT20B10G7	1314147	Ex9CKT20B10G7Q	1314086
208~240	Ex9CKT20B10XU7	1314148	Ex9CKT20B10XU7Q	1314087
277	Ex9CKT20B10N7	1314149	Ex9CKT20B10N7Q	1314088
440	Ex9CKT20B10R7	1314150	Ex9CKT20B10R7Q	1314089
480	Ex9CKT20B10T7	1314151	Ex9CKT20B10T7Q	1314090
600	Ex9CKT20B10Y7	1314012	Ex9CKT20B10Y7Q	1314629

20A, Lug, 50/60Hz, Dual QCT 20A, Lug, 50/60Hz, Quad QCT

Coil Voltage Vac	2 Pole 2NO		2 Pole 2NO	
	Product	Part Number	Product	Part Number
24	Ex9CKT20B20B7	1314461	Ex9CKT20B20B7Q	1314201
120	Ex9CKT20B20G7	1314462	Ex9CKT20B20G7Q	1314402
208~240	Ex9CKT20B20XU7	1314463	Ex9CKT20B20XU7Q	1314403
277	Ex9CKT20B20N7	1314464	Ex9CKT20B20N7Q	1314404
440	Ex9CKT20B20R7	1314465	Ex9CKT20B20R7Q	1314405
480	Ex9CKT20B20T7	1314466	Ex9CKT20B20T7Q	1314406
600	Ex9CKT20B20Y7	1314017	Ex9CKT20B20Y7Q	1314634

20A, Lug, 50/60Hz, Dual QCT 20A, Lug, 50/60Hz, Dual QCT

Coil Voltage Vac	3 Pole 3NO		4 Pole 4NO	
	Product	Part Number	Product	Part Number
24	Ex9CKT20B30B7	1314282	Ex9CKT20B40B7	1314342
120	Ex9CKT20B30G7	1314283	Ex9CKT20B40G7	1314343
208~240	Ex9CKT20B30XU7	1314284	Ex9CKT20B40XU7	1314344
277	Ex9CKT20B30N7	1314285	Ex9CKT20B40N7	1314345
440	Ex9CKT20B30R7	1314286	Ex9CKT20B40R7	1314346
480	Ex9CKT20B30T7	1314287	Ex9CKT20B40T7	1314347
600	Ex9CKT20B30Y7	1314073	Ex9CKT20B40Y7	1314078

Definite Purpose Contactors

Ex9CKT 25A

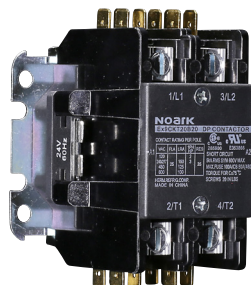

Certifications
 IEC/EN 60947-4-1

25A, Screw, 50/60Hz, Dual QCT

25A, Screw, 50/60Hz, Quad QCT

Coil Voltage Vac	1 Pole 1NO+1Shunt		1 Pole 1NO+1Shunt	
	Product	Part Number	Product	Part Number
24	Ex9CKT25A10B7	1314183	Ex9CKT25A10B7Q	1314121
120	Ex9CKT25A10G7	1314184	Ex9CKT25A10G7Q	1314122
208~240	Ex9CKT25A10XU7	1314185	Ex9CKT25A10XU7Q	1314123
277	Ex9CKT25A10N7	1314186	Ex9CKT25A10N7Q	1314124
440	Ex9CKT25A10R7	1314187	Ex9CKT25A10R7Q	1314125
480	Ex9CKT25A10T7	1314188	Ex9CKT25A10T7Q	1314126
600	Ex9CKT25A10Y7	1313993	Ex9CKT25A10Y7Q	1314084

25A, Screw, 50/60Hz, Dual QCT

25A, Screw, 50/60Hz, Quad QCT

Coil Voltage Vac	2 Pole 2NO		2 Pole 2NO	
	Product	Part Number	Product	Part Number
24	Ex9CKT25A20B7	1314497	Ex9CKT25A20B7Q	1314437
120	Ex9CKT25A20G7	1314498	Ex9CKT25A20G7Q	1314438
208~240	Ex9CKT25A20XU7	1314499	Ex9CKT25A20XU7Q	1314439
277	Ex9CKT25A20N7	1314500	Ex9CKT25A20N7Q	1314440
440	Ex9CKT25A20R7	1314501	Ex9CKT25A20R7Q	1314441
480	Ex9CKT25A20T7	1314502	Ex9CKT25A20T7Q	1314442
600	Ex9CKT25A20Y7	1313998	Ex9CKT25A20Y7Q	1314624

25A, Screw, 50/60Hz, Dual QCT

25A, Screw, 50/60Hz, Dual QCT

Coil Voltage Vac	3 Pole 3NO		4 Pole 4NO	
	Product	Part Number	Product	Part Number
24	Ex9CKT25A30B7	1314318	Ex9CKT25A40B7	1314378
120	Ex9CKT25A30G7	1314319	Ex9CKT25A40G7	1314379
208~240	Ex9CKT25A30XU7	1314320	Ex9CKT25A40XU7	1314380
277	Ex9CKT25A30N7	1314321	Ex9CKT25A40N7	1314381
440	Ex9CKT25A30R7	1314322	Ex9CKT25A40R7	1314382
480	Ex9CKT25A30T7	1314323	Ex9CKT25A40T7	1314383
600	Ex9CKT25A30Y7	1314003	Ex9CKT25A40Y7	1314008

F

Definite Purpose Contactors

Ex9CKT 25A

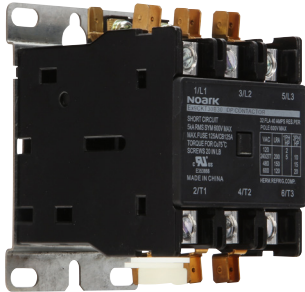

25A, Lug, 50/60Hz, Dual QCT

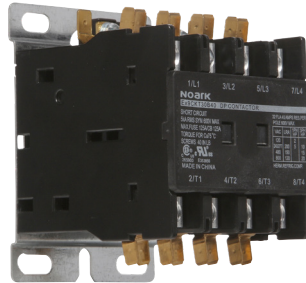

25A, Screw, 50/60Hz, Quad QCT



Coil Voltage Vac	1 Pole 1NO+1Shunt		1 Pole 1NO+1Shunt	
	Product	Part Number	Product	Part Number
24	Ex9CKT25B10B7	1314152	Ex9CKT25B10B7Q	1314091
120	Ex9CKT25B10G7	1314153	Ex9CKT25B10G7Q	1314092
208~240	Ex9CKT25B10XU7	1314154	Ex9CKT25B10XU7Q	1314093
277	Ex9CKT25B10N7	1314155	Ex9CKT25B10N7Q	1314094
440	Ex9CKT25B10R7	1314156	Ex9CKT25B10R7Q	1314095
480	Ex9CKT25B10T7	1314157	Ex9CKT25B10T7Q	1314096
600	Ex9CKT25B10Y7	1314013	Ex9CKT25B10Y7Q	1314630

25A, Lug, 50/60Hz, Dual QCT

25A, Screw, 50/60Hz, Quad QCT

Coil Voltage Vac	2 Pole 2NO		2 Pole 2NO	
	Product	Part Number	Product	Part Number
24	Ex9CKT25B20B7	1314467	Ex9CKT25B20B7Q	1314407
120	Ex9CKT25B20G7	1314468	Ex9CKT25B20G7Q	1314408
208~240	Ex9CKT25B20XU7	1314469	Ex9CKT25B20XU7Q	1314409
277	Ex9CKT25B20N7	1314470	Ex9CKT25B20N7Q	1314410
440	Ex9CKT25B20R7	1314471	Ex9CKT25B20R7Q	1314411
480	Ex9CKT25B20T7	1314472	Ex9CKT25B20T7Q	1314412
600	Ex9CKT25B20Y7	1314018	Ex9CKT25B20Y7Q	1314635

25A, Lug, 50/60Hz, Dual QCT

25A, Screw, 50/60Hz, Dual QCT

Coil Voltage Vac	3 Pole 3NO		4 Pole 4NO	
	Product	Part Number	Product	Part Number
24	Ex9CKT25B30B7	1314288	Ex9CKT25B40B7	1314348
120	Ex9CKT25B30G7	1314289	Ex9CKT25B40G7	1314349
208~240	Ex9CKT25B30XU7	1314290	Ex9CKT25B40XU7	1314350
277	Ex9CKT25B30N7	1314291	Ex9CKT25B40N7	1314351
440	Ex9CKT25B30R7	1314292	Ex9CKT25B40R7	1314352
480	Ex9CKT25B30T7	1314293	Ex9CKT25B40T7	1314353
600	Ex9CKT25B30Y7	1314074	Ex9CKT25B40Y7	1314079

Definite Purpose Contactors

Ex9CKT 30A

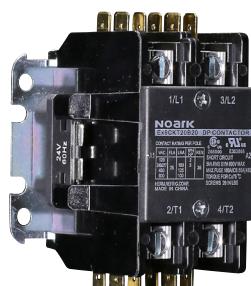

Certifications
IEC/EN 60947-4-1

30A, Screw, 50/60Hz, Dual QCT

30A, Screw, 50/60Hz, Quad QCT

Coil Voltage Vac	1 Pole 1NO+1Shunt		1 Pole 1NO+1Shunt	
	Product	Part Number	Product	Part Number
24	Ex9CKT30A10B7	1314189	Ex9CKT30A10B7Q	1314127
120	Ex9CKT30A10G7	1314190	Ex9CKT30A10G7Q	1314128
208~240	Ex9CKT30A10XU7	1314191	Ex9CKT30A10XU7Q	1314129
277	Ex9CKT30A10N7	1314692	Ex9CKT30A10N7Q	1314130
440	Ex9CKT30A10R7	1314693	Ex9CKT30A10R7Q	1314131
480	Ex9CKT30A10T7	1314694	Ex9CKT30A10T7Q	1314132
600	Ex9CKT30A10Y7	1313994	Ex9CKT30A10Y7Q	1314620

30A, Screw, 50/60Hz, Dual QCT

30A, Screw, 50/60Hz, Quad QCT

Coil Voltage Vac	2 Pole 2NO		2 Pole 2NO	
	Product	Part Number	Product	Part Number
24	Ex9CKT30A20B7	1314503	Ex9CKT30A20B7Q	1314443
120	Ex9CKT30A20G7	1314504	Ex9CKT30A20G7Q	1314444
208~240	Ex9CKT30A20XU7	1314505	Ex9CKT30A20XU7Q	1314445
277	Ex9CKT30A20N7	1314506	Ex9CKT30A20N7Q	1314446
440	Ex9CKT30A20R7	1314507	Ex9CKT30A20R7Q	1314447
480	Ex9CKT30A20T7	1314508	Ex9CKT30A20T7Q	1314448
600	Ex9CKT30A20Y7	1313999	Ex9CKT30A20Y7Q	1314625

30A, Screw, 50/60Hz, Dual QCT

30A, Screw, 50/60Hz, Dual QCT

Coil Voltage Vac	3 Pole 3NO		4 Pole 4NO	
	Product	Part Number	Product	Part Number
24	Ex9CKT30A30B7	1314324	Ex9CKT30A40B7	1314384
120	Ex9CKT30A30G7	1314325	Ex9CKT30A40G7	1314385
208~240	Ex9CKT30A30XU7	1314326	Ex9CKT30A40XU7	1314386
277	Ex9CKT30A30N7	1314327	Ex9CKT30A40N7	1314387
440	Ex9CKT30A30R7	1314328	Ex9CKT30A40R7	1314388
480	Ex9CKT30A30T7	1314329	Ex9CKT30A40T7	1314389
600	Ex9CKT30A30Y7	1314004	Ex9CKT30A40Y7	1314009

F

Definite Purpose Contactors

Ex9CKT 30A

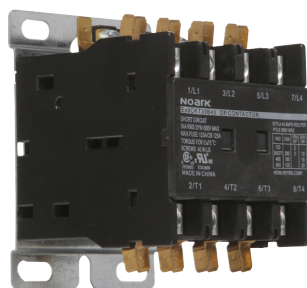

30A, Lug, 50/60Hz, Dual QCT 30A, Lug, 50/60Hz, Quad QCT

Coil Voltage Vac	1 Pole 1NO+1Shunt		1 Pole 1NO+1Shunt	
	Product	Part Number	Product	Part Number
24	Ex9CKT30B10B7	1314158	Ex9CKT30B10B7Q	1314097
120	Ex9CKT30B10G7	1314160	Ex9CKT30B10G7Q	1314098
208~240	Ex9CKT30B10XU7	1314161	Ex9CKT30B10XU7Q	1314099
277	Ex9CKT30B10N7	1314162	Ex9CKT30B10N7Q	1314100
440	Ex9CKT30B10R7	1314163	Ex9CKT30B10R7Q	1314101
480	Ex9CKT30B10T7	1314164	Ex9CKT30B10T7Q	1314102
600	Ex9CKT30B10Y7	1314014	Ex9CKT30B10Y7Q	1314631

30A, Lug, 50/60Hz, Dual QCT 30A, Lug, 50/60Hz, Quad QCT

Coil Voltage Vac	2 Pole 2NO		2 Pole 2NO	
	Product	Part Number	Product	Part Number
24	Ex9CKT30B20B7	1314473	Ex9CKT30B20B7Q	1314413
120	Ex9CKT30B20G7	1314474	Ex9CKT30B20G7Q	1314414
208~240	Ex9CKT30B20XU7	1314475	Ex9CKT30B20XU7Q	1314415
277	Ex9CKT30B20N7	1314476	Ex9CKT30B20N7Q	1314416
440	Ex9CKT30B20R7	1314477	Ex9CKT30B20R7Q	1314417
480	Ex9CKT30B20T7	1314478	Ex9CKT30B20T7Q	1314418
600	Ex9CKT30B20Y7	1314019	Ex9CKT30B20Y7Q	1314636

30A, Lug, 50/60Hz, Dual QCT 30A, Lug, 50/60Hz, Dual QCT

Coil Voltage Vac	3 Pole 3NO		4 Pole 4NO	
	Product	Part Number	Product	Part Number
24	Ex9CKT30B30B7	1314294	Ex9CKT30B40B7	1314354
120	Ex9CKT30B30G7	1314295	Ex9CKT30B40G7	1314355
208~240	Ex9CKT30B30XU7	1314296	Ex9CKT30B40XU7	1314356
277	Ex9CKT30B30N7	1314297	Ex9CKT30B40N7	1314357
440	Ex9CKT30B30R7	1314298	Ex9CKT30B40R7	1314358
480	Ex9CKT30B30T7	1314299	Ex9CKT30B40T7	1314359
600	Ex9CKT30B30Y7	1314075	Ex9CKT30B40Y7	1314080

Definite Purpose Contactors

Ex9CKT 32A

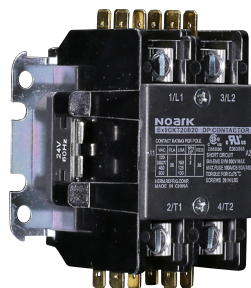

Certifications
IEC/EN 60947-4-1

32A, Screw, 50/60Hz, Dual QCT

32A, Screw, 50/60Hz, Quad QCT

Coil Voltage Vac	1 Pole 1NO+1Shunt		1 Pole 1NO+1Shunt	
	Product	Part Number	Product	Part Number
24	Ex9CKT32A10B7	1314695	Ex9CKT32A10B7Q	1314133
120	Ex9CKT32A10G7	1314704	Ex9CKT32A10G7Q	1314134
208~240	Ex9CKT32A10XU7	1314705	Ex9CKT32A10XU7Q	1314135
277	Ex9CKT32A10N7	1314706	Ex9CKT32A10N7Q	1314136
440	Ex9CKT32A10R7	1314707	Ex9CKT32A10R7Q	1314137
480	Ex9CKT32A10T7	1314716	Ex9CKT32A10T7Q	1314139
600	Ex9CKT32A10Y7	1313995	Ex9CKT32A10Y7Q	1314621

32A, Screw, 50/60Hz, Dual QCT

32A, Screw, 50/60Hz, Quad QCT

Coil Voltage Vac	2 Pole 2NO		2 Pole 2NO	
	Product	Part Number	Product	Part Number
24	Ex9CKT32A20B7	1314509	Ex9CKT32A20B7Q	1314449
120	Ex9CKT32A20G7	1314510	Ex9CKT32A20G7Q	1314450
208~240	Ex9CKT32A20XU7	1314511	Ex9CKT32A20XU7Q	1314451
277	Ex9CKT32A20N7	1314512	Ex9CKT32A20N7Q	1314452
440	Ex9CKT32A20R7	1314513	Ex9CKT32A20R7Q	1314453
480	Ex9CKT32A20T7	1314514	Ex9CKT32A20T7Q	1314454
600	Ex9CKT32A20Y7	1314000	Ex9CKT32A20Y7Q	1314626

32A, Screw, 50/60Hz, Dual QCT

32A, Screw, 50/60Hz, Dual QCT

Coil Voltage Vac	3 Pole 3NO		4 Pole 4NO	
	Product	Part Number	Product	Part Number
24	Ex9CKT32A30B7	1314330	Ex9CKT32A40B7	1314390
120	Ex9CKT32A30G7	1314331	Ex9CKT32A40G7	1314391
208~240	Ex9CKT32A30XU7	1314332	Ex9CKT32A40XU7	1314392
277	Ex9CKT32A30N7	1314333	Ex9CKT32A40N7	1314393
440	Ex9CKT32A30R7	1314334	Ex9CKT32A40R7	1314394
480	Ex9CKT32A30T7	1314335	Ex9CKT32A40T7	1314395
600	Ex9CKT32A30Y7	1314005	Ex9CKT32A40Y7	1314010

F

Definite Purpose Contactors

Ex9CKT 32A

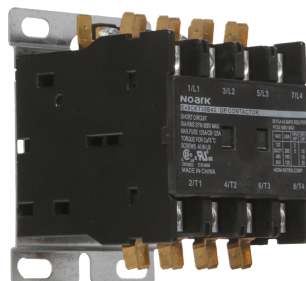

32A, Lug, 50/60Hz, Dual QCT 32A, Lug, 50/60Hz, Quad QCT

Coil Voltage Vac	1 Pole 1NO+1Shunt		1 Pole 1NO+1Shunt	
	Product	Part Number	Product	Part Number
24	Ex9CKT32B10B7	1314165	Ex9CKT32B10B7Q	1314103
120	Ex9CKT32B10G7	1314166	Ex9CKT32B10G7Q	1314104
208~240	Ex9CKT32B10XU7	1314167	Ex9CKT32B10XU7Q	1314105
277	Ex9CKT32B10N7	1314168	Ex9CKT32B10N7Q	1314106
440	Ex9CKT32B10R7	1314169	Ex9CKT32B10R7Q	1314107
480	Ex9CKT32B10T7	1314170	Ex9CKT32B10T7Q	1314108
600	Ex9CKT32B10Y7	1314015	Ex9CKT32B10Y7Q	1314632

32A, Lug, 50/60Hz, Dual QCT 32A, Lug, 50/60Hz, Quad QCT

Coil Voltage Vac	2 Pole 2NO		2 Pole 2NO	
	Product	Part Number	Product	Part Number
24	Ex9CKT32B20B7	1314479	Ex9CKT32B20B7Q	1314419
120	Ex9CKT32B20G7	1314480	Ex9CKT32B20G7Q	1314420
208~240	Ex9CKT32B20XU7	1314481	Ex9CKT32B20XU7Q	1314421
277	Ex9CKT32B20N7	1314482	Ex9CKT32B20N7Q	1314422
440	Ex9CKT32B20R7	1314483	Ex9CKT32B20R7Q	1314423
480	Ex9CKT32B20T7	1314484	Ex9CKT32B20T7Q	1314424
600	Ex9CKT32B20Y7	1314071	Ex9CKT32B20Y7Q	1314637

32A, Lug, 50/60Hz, Dual QCT 32A, Lug, 50/60Hz, Dual QCT

Coil Voltage Vac	3 Pole 3NO		4 Pole 4NO	
	Product	Part Number	Product	Part Number
24	Ex9CKT32B30B7	1314300	Ex9CKT32B40B7	1314360
120	Ex9CKT32B30G7	1314301	Ex9CKT32B40G7	1314361
208~240	Ex9CKT32B30XU7	1314302	Ex9CKT32B40XU7	1314362
277	Ex9CKT32B30N7	1314303	Ex9CKT32B40N7	1314363
440	Ex9CKT32B30R7	1314304	Ex9CKT32B40R7	1314364
480	Ex9CKT32B30T7	1314305	Ex9CKT32B40T7	1314365
600	Ex9CKT32B30Y7	1314076	Ex9CKT32B40Y7	1314081

Definite Purpose Contactors

Ex9CKT 40A

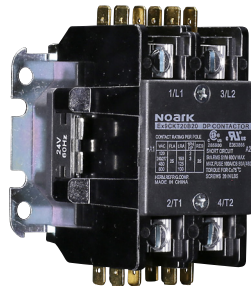

Certifications
IEC/EN 60947-4-1

40A, Screw, 50/60Hz, Dual QCT

40A, Screw, 50/60Hz, Quad QCT

Coil Voltage Vac	1 Pole 1NO+1Shunt		1 Pole 1NO+1Shunt	
	Product	Part Number	Product	Part Number
24	Ex9CKT40A10B7	1314717	Ex9CKT40A10B7Q	1314140
120	Ex9CKT40A10G7	1314718	Ex9CKT40A10G7Q	1314141
208-240	Ex9CKT40A10XU7	1314719	Ex9CKT40A10XU7Q	1314142
277	Ex9CKT40A10N7	1314728	Ex9CKT40A10N7Q	1314143
440	Ex9CKT40A10R7	1314729	Ex9CKT40A10R7Q	1314144
480	Ex9CKT40A10T7	1314730	Ex9CKT40A10T7Q	1314145
600	Ex9CKT40A10Y7	1313996	Ex9CKT40A10Y7Q	1314622

40A, Screw, 50/60Hz, Dual QCT

40A, Screw, 50/60Hz, Quad QCT

Coil Voltage Vac	2 Pole 2NO		2 Pole 2NO	
	Product	Part Number	Product	Part Number
24	Ex9CKT40A20B7	1314515	Ex9CKT40A20B7Q	1314455
120	Ex9CKT40A20G7	1314516	Ex9CKT40A20G7Q	1314456
208-240	Ex9CKT40A20XU7	1314517	Ex9CKT40A20XU7Q	1314457
277	Ex9CKT40A20N7	1314518	Ex9CKT40A20N7Q	1314458
440	Ex9CKT40A20R7	1314519	Ex9CKT40A20R7Q	1314459
480	Ex9CKT40A20T7	1314520	Ex9CKT40A20T7Q	1314460
600	Ex9CKT40A20Y7	1314001	Ex9CKT40A20Y7Q	1314627

40A, Screw, 50/60Hz, Dual QCT

40A, Screw, 50/60Hz, Dual QCT

Coil Voltage Vac	3 Pole 3NO		4 Pole 4NO	
	Product	Part Number	Product	Part Number
24	Ex9CKT40A30B7	1314336	Ex9CKT40A40B7	1314396
120	Ex9CKT40A30G7	1314337	Ex9CKT40A40G7	1314397
208-240	Ex9CKT40A30XU7	1314338	Ex9CKT40A40XU7	1314398
277	Ex9CKT40A30N7	1314339	Ex9CKT40A40N7	1314399
440	Ex9CKT40A30R7	1314340	Ex9CKT40A40R7	1314400
480	Ex9CKT40A30T7	1314341	Ex9CKT40A40T7	1314401
600	Ex9CKT40A30Y7	1314006	Ex9CKT40A40Y7	1314011

F

Definite Purpose Contactors

Ex9CKT 40A

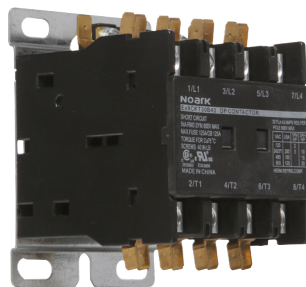
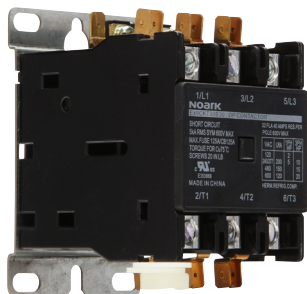

40A, Lug, 50/60Hz, Dual QCT 40A, Lug, 50/60Hz, Dual QCT

Coil Voltage Vac	1 Pole 1NO+1Shunt		1 Pole 1NO+1Shunt	
	Product	Part Number	Product	Part Number
24	Ex9CKT40B10B7	1314171	Ex9CKT40B10B7Q	1314109
120	Ex9CKT40B10G7	1314172	Ex9CKT40B10G7Q	1314110
208~240	Ex9CKT40B10XU7	1314173	Ex9CKT40B10XU7Q	1314111
277	Ex9CKT40B10N7	1314174	Ex9CKT40B10N7Q	1314112
440	Ex9CKT40B10R7	1314175	Ex9CKT40B10R7Q	1314113
480	Ex9CKT40B10T7	1314176	Ex9CKT40B10T7Q	1314114
600	Ex9CKT40B10Y7	1314016	Ex9CKT40B10Y7Q	1314633

40A, Lug, 50/60Hz, Dual QCT 40A, Lug, 50/60Hz, Dual QCT

Coil Voltage Vac	2 Pole 2NO		2 Pole 2NO	
	Product	Part Number	Product	Part Number
24	Ex9CKT40B20B7	1314485	Ex9CKT40B20B7Q	1314425
120	Ex9CKT40B20G7	1314486	Ex9CKT40B20G7Q	1314426
208~240	Ex9CKT40B20XU7	1314487	Ex9CKT40B20XU7Q	1314427
277	Ex9CKT40B20N7	1314488	Ex9CKT40B20N7Q	1314428
440	Ex9CKT40B20R7	1314489	Ex9CKT40B20R7Q	1314429
480	Ex9CKT40B20T7	1314490	Ex9CKT40B20T7Q	1314430
600	Ex9CKT40B20Y7	1314072	Ex9CKT40B20Y7Q	1314638

40A, Lug, 50/60Hz, Dual QCT 40A, Lug, 50/60Hz, Dual QCT

Coil Voltage Vac	3 Pole 3NO		4 Pole 4NO	
	Product	Part Number	Product	Part Number
24	Ex9CKT40B30B7	1314306	Ex9CKT40B40B7	1314366
120	Ex9CKT40B30G7	1314307	Ex9CKT40B40G7	1314367
208~240	Ex9CKT40B30XU7	1314308	Ex9CKT40B40XU7	1314368
277	Ex9CKT40B30N7	1314309	Ex9CKT40B40N7	1314369
440	Ex9CKT40B30R7	1314310	Ex9CKT40B40R7	1314370
480	Ex9CKT40B30T7	1314311	Ex9CKT40B40T7	1314371
600	Ex9CKT40B30Y7	1314077	Ex9CKT40B40Y7	1314082

Definite Purpose Contactors

Ex9CKT Packaging

Packaging

Full Load Amperage (A)	Poles	MOQ	Quantity (pc/carton)	Carton Weight lbs (kgs)		Piece Weight lbs (kgs)		Carton Dimensions in (mm)
				Gross	Net	Gross	Net	
20	1	64	64	45.03 (20.42)	40.96 (18.60)	0.7 (0.32)	0.64(0.29)	15.67x9.53x12.64 (398x250x335)
25	1	64	64	45.03 (20.42)	40.96 (18.60)	0.7 (0.32)	0.64(0.29)	
30	1	64	64	45.03 (20.42)	40.96 (18.60)	0.7 (0.32)	0.64(0.29)	
32	1	64	64	45.03 (20.42)	40.96 (18.60)	0.7 (0.32)	0.64(0.29)	
40	1	64	64	45.03 (20.42)	40.96 (18.60)	0.7 (0.32)	0.64(0.29)	
20	2	64	64	53.62 (24.32)	48.00 (21.77)	0.84(0.38)	0.75(0.34)	
25	2	64	64	53.62 (24.32)	48.00 (21.77)	0.84(0.38)	0.75(0.34)	
30	2	64	64	53.62 (24.32)	48.00 (21.77)	0.84(0.38)	0.75(0.34)	
32	2	64	64	53.62 (24.32)	48.00 (21.77)	0.84(0.38)	0.75(0.34)	
40	2	64	64	53.62 (24.32)	48.00 (21.77)	0.84(0.38)	0.75(0.34)	
20	3	54	54	56.48(25.62)	52.14(23.65)	1.04(0.47)	0.97(0.44)	15.67x9.53x12.64 (476x325x291)
25	3	54	54	56.48(25.62)	52.14(23.65)	1.04(0.47)	0.97(0.44)	
30	3	54	54	56.48(25.62)	52.14(23.65)	1.04(0.47)	0.97(0.44)	
32	3	54	54	56.48(25.62)	52.14(23.65)	1.04(0.47)	0.97(0.44)	
40	3	54	54	56.48(25.62)	52.14(23.65)	1.04(0.47)	0.97(0.44)	
20	4	24	24	32.83(14.89)	30.42(13.8)	1.37(0.62)	1.27(0.58)	15.67x9.53x12.64 (424x254x206)
25	4	24	24	32.83(14.89)	30.42(13.8)	1.37(0.62)	1.27(0.58)	
30	4	24	24	32.83(14.89)	30.42(13.8)	1.37(0.62)	1.27(0.58)	
32	4	24	24	32.83(14.89)	30.42(13.8)	1.37(0.62)	1.27(0.58)	
40	4	24	24	32.83(14.89)	30.42(13.8)	1.37(0.62)	1.27(0.58)	

F

Definite Purpose Contactors

Ex9CKT Specifications

20~40 FLA

Description	Poles	Full Load Amperage (A)			Resistive @ 600 Vac (A)	Locked Rotor (A)			Horsepower (hp)		
		240/277 V	480 V	600 V		240/277 V	480 V	600 V	Voltage (V)	1-Phase	3-Phase
Ex9CKT20	1&2				35	150	125	100	120	1	-
									240	2	-
									120	2	-
									240	3	-
Ex9CKT25	1&2		25		35	150	125	100	120	1	-
									240	2	-
									120	2	-
									240	3	-
Ex9CKT30	1&2				40	200	150	120	120	1	-
									240	2	-
									120	2	-
									240	3	-
Ex9CKT32	1&2		32		40	200	150	120	120	1	-
									240	2	-
									120	2	-
									240	3	-
Ex9CKT40	1&2				50	240	200	160	120	2	-
									240	3	-
									120	2	-
									240	3	-
Ex9CKT20	3 & 4				35	150	125	100	240/277	5	10
									480	-	15
									600	-	20
									120	2	-
Ex9CKT25	3 & 4		25		35	150	125	100	240/277	5	10
									480	-	15
									600	-	20
									120	2	-
Ex9CKT30	3 & 4				40	200	150	120	120	2	-
									240/277	5	10
									480	-	15
									600	-	20
Ex9CKT32	3 & 4		32		40	200	150	120	120	2	-
									240/277	5	10
									480	-	15
									600	-	20
Ex9CKT40	3 & 4				50	240	200	160	120	3	-
									240/277	7.5	10
									480	-	20
									600	-	25

Mechanical & Electrical Life

Mechanical	1,000,000 cycles
Electrical	250,000 cycle (AC Resistance Air Heating Load) /100,000 cycle (Inductive Load)

Definite Purpose Contactors

Ex9CKT Specifications

20~40 FLA Coil

1 Pole Contactors (20-40A)

	Coil Data						
	24V	120V	208-240V	277V	440V	480V	600V
Nominal Coil Resistance (Ω)	14.8	420	1185	2050	5400	6890	9480
Nominal Coil Voltage (Vac)	24	120	208-240	277	440	480	600
Pick-up Voltage (Max)	20.4	102	177	236	374	408	510
Drop-out Voltage (Min)	4.8	24	48	56	88	96	120
Nominal Inrush (VA)							
50Hz	32	32	32	32	32	32	32
60Hz	31.5	31.5	31.5	31.5	31.5	31.5	31.5
Nominal Seal (VA)							
50Hz	9.3	9.3	9.3	9.3	9.3	9.3	9.3
60Hz	9	9	9	9	9	9	9

F

2 Pole Contactors (20-40A)

	Coil Data						
	24V	120V	208-240V	277V	440V	480V	600V
Nominal Coil Resistance (Ω)	10.5	250	880	1400	3630	3845	6250
Nominal Coil Voltage (Vac)	24V	120V	208-240V	277V	440	480	600
Pick-up Voltage (Max)	20.4	102	177	236	374	408	510
Drop-out Voltage (Min)	4.8	24	48	56	88	96	120
Nominal Inrush (VA)							
50Hz	40	40	40	40	40	40	40
60Hz	38.5	38.5	38.5	38.5	38.5	38.5	38.5
Nominal Seal (VA)							
50Hz	10	10	10	10	10	10	10
60Hz	9.5	9.5	9.5	9.5	9.5	9.5	9.5

Definite Purpose Contactors

Ex9CKT Specifications

20~40 FLA Coil

3 Pole Contactors (20-40A)

	Coil Data						
	24V	120V	208-240V	277V	440V	480V	600V
Nominal Coil Resistance (Ω)	8.5	178	630	1180	1205	2650	5150
Nominal Coil Voltage (Vac)	24	120	208 - 240	277	440	480	600
Pick-up Voltage (Max)	20.4	102	177	236	374	408	510
Drop-out Voltage (Min)	4.8	24	48	56	88	96	120
Nominal Inrush (VA)							
50Hz	60	60	75	60	60	60	60
60Hz	53	53	68	53	53	53	53
Nominal Seal (VA)							
50Hz	8	8	11	8	8	8	8
60Hz	6.5	6.5	8.8	6.5	6.5	6.5	6.5

4 Pole Contactors (20-40A)

	Coil Data						
	24V	120V	208-240V	277V	440V	480V	600V
Nominal Coil Resistance(Ω)	6	152.5	527	790	1700	2530	3480
Nominal Coil Voltage (Vac)	24	120	208 - 240	277	440	408	600
Pick-up Voltage (Max)	20.4	102	177	236	374	320	510
Drop-out Voltage (Min)	4.8	24	48	56	88	96	120
Nominal Inrush (VA)							
50Hz	80.5	80.5	80.5	80.5	84	80.5	80.5
60Hz	73	73	73	73	76	73	73
Nominal Seal (VA)							
50Hz	10.5	10.5	10.5	10.5	10.5	10.5	10.5
60Hz	8.8	8.8	8.8	8.8	8.8	8.5	8.8

Definite Purpose Contactors

Ex9CKT Specifications

20~40 FLA Terminal

1 and 2 Pole (20-40A)

			20	25	30	32	40	
Line and Load Terminals			#10-32 Screw Box Lug					
Copper Cable AWG (mm ²)	Ridge Wire with Single Core	Screw	14~10 (2.5~6)		12~8 (6~10)		10~8 (4~10)	
		Lug	14~10 (2.5~6)		12~8 (6~10)		10~8 (4~10)	
	Flexible Stranded Wire	Screw	14~12 (2.5~4)		14~10 (2.5~6)		14~10 (2.5~6)	
		Lug	14~12 (2.5~4)		14~10 (2.5~6)		14~10 (2.5~6)	
Tightening Torque in-lb (N.m)	Coil		-					
	Main Circuit	Screw	20 (2.3)					
		Lug	40 (4.5)					
Quick Connects	Coil Terminals		Dual 0.250 QC (2)					
	Power Terminals		Dual 0.25 QC (2 or 4)					
Insulation System			Class B 266 °F (130 °C)					

3 and 4 Pole (20-40A)

			20	25	30	32	40		
Line and Load Terminals			#10-32 Screw Box Lug					F	
Copper Cable AWG (mm ²)	Ridge Wire with Single Core	Screw	14~10 (2.5~6)	12~8 (4~10)	16~8 (1.5~10)	2~8 (4~10)	16~8 (1.5~10)	2~8 (4~10)	16~8 (1.5~10)
		Lug	14~8 (2.5~10)						
	Flexible Stranded Wire	Screw	14~12 (2.5~6)						
		Lug	14~8 (2.5~10)						
Tightening Torque in-lb (N.m)	Coil	10.5(1.2)							
	Main Circuit	Screw	20 (2.3)						
		Lug	40 (4.5)						
Quick Connects	Coil Terminals		Dual 0.250 QC (2)						
	Power Terminals		3/4P Dual						
Insulation System			Class B 266 °F (130 °C)						

Definite Purpose Contactors

Ex9CKT Specifications

SCCR Ratings

* CB: must be NOARK UL MCCB M1N

SCCR (kA)	Ex9CKT	600V		480V	
		Fuse Type	Max. Rated Current	CB*	Max. Rated Current
100	Ex9CKT20...	Class J	80A	M1H50T3L	50A
	Ex9CKT25...				
	Ex9CKT30...				
	Ex9CKT32...				
	Ex9CKT40...		100A	M1H70T3L	70A

Lighting Data

25-40A; 1P/2P

Inductive Rating (DP Contactor FLA)	Tungsten & Ballast Rating
25A	30A
30A	40A
40A	40A (Ballast) 50A (Tungsten)

25-40A; 3P/4P

Inductive Rating (DP Contactor FLA)	Tungsten & Ballast Rating
25A	30A
30A	40A
40A	40A (Ballast) 50A (Tungsten)

Definite Purpose Contactors

Ex9CKT Dimensions 20~40

Ex9CKT20~40 Screw

1 Pole

Unit: in. [mm]

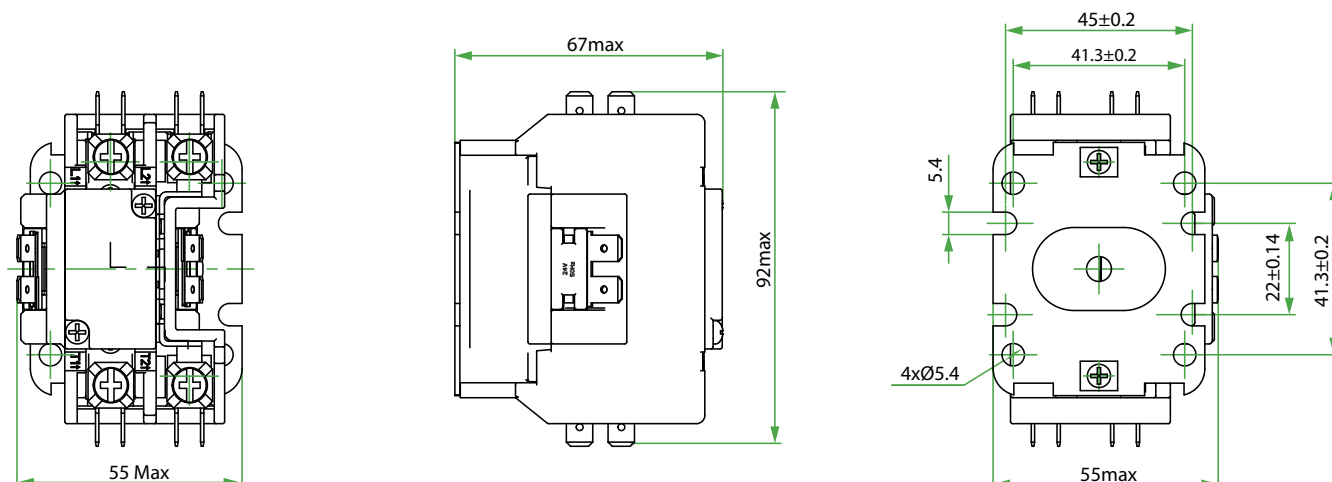

Ex9CKT20~40 Lug

1 Pole

Unit: in. [mm]

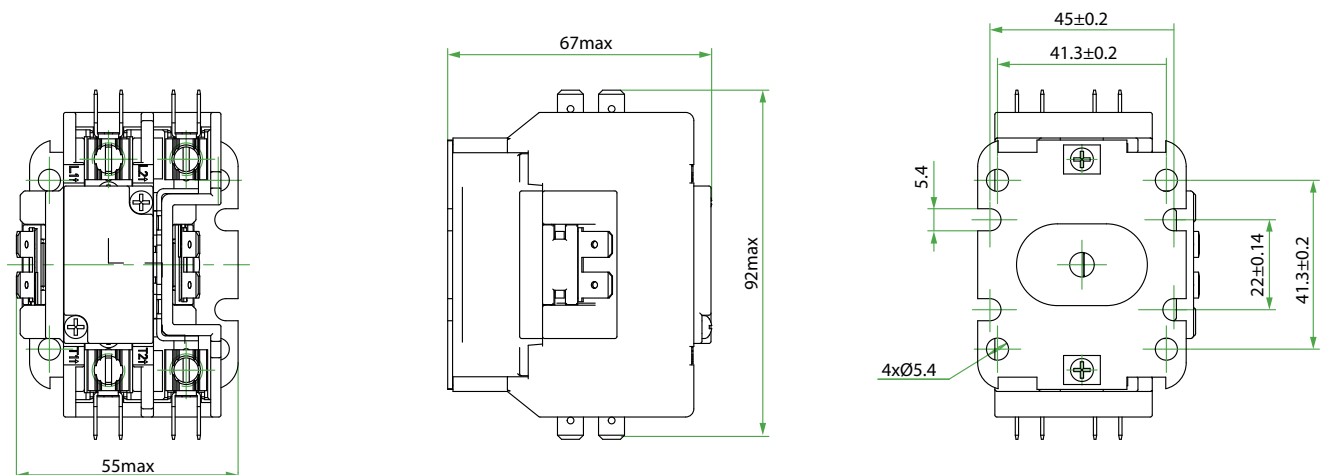

F

Definite Purpose Contactors

Ex9CKT Dimensions 20~40

Ex9CKT20~40 Screw

2 Pole

Unit: in. [mm]

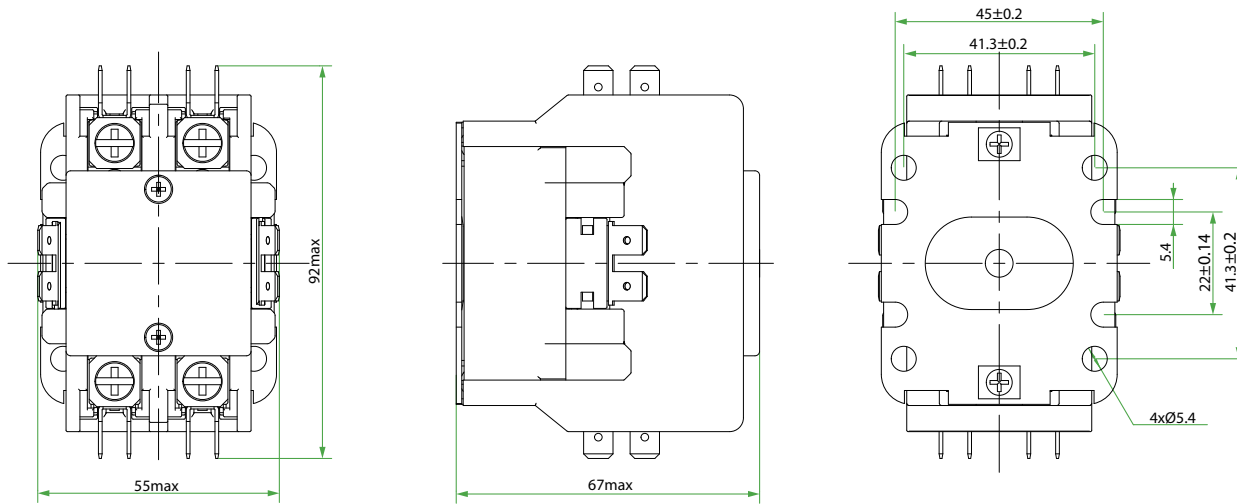

Ex9CKT20~40 Lug

2 Pole

Unit: in. [mm]

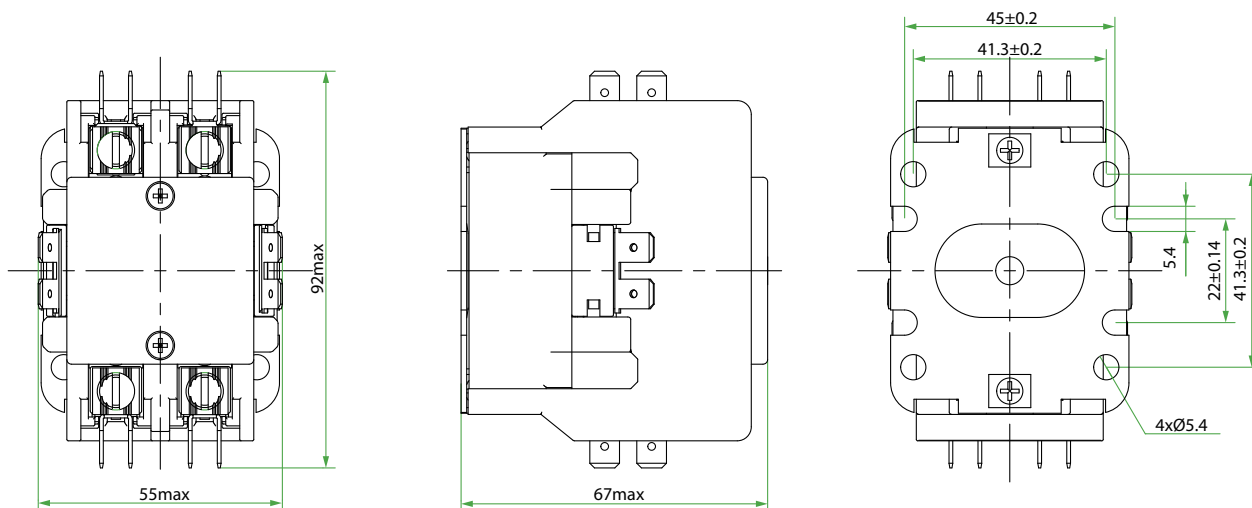

Definite Purpose Contactors

Ex9CKT Dimensions 20~40

Ex9CKT20~40

3 Pole

Unit: in. [mm]

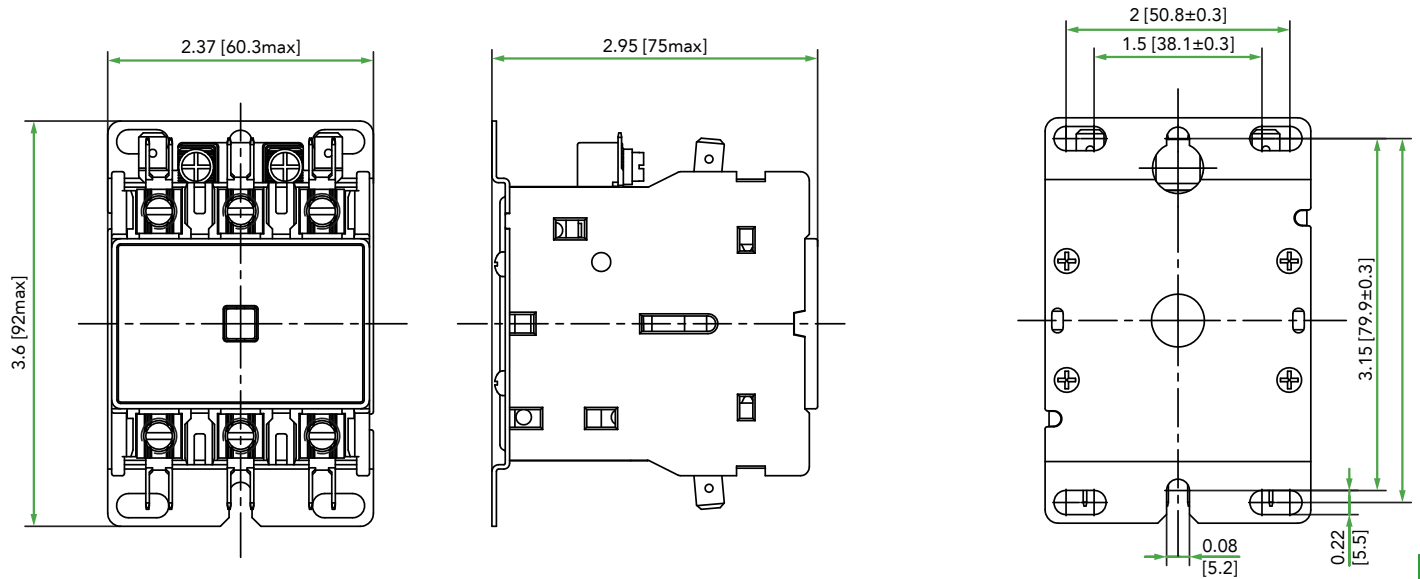

Ex9CKT20~40

4 Pole

Unit: in. [mm]

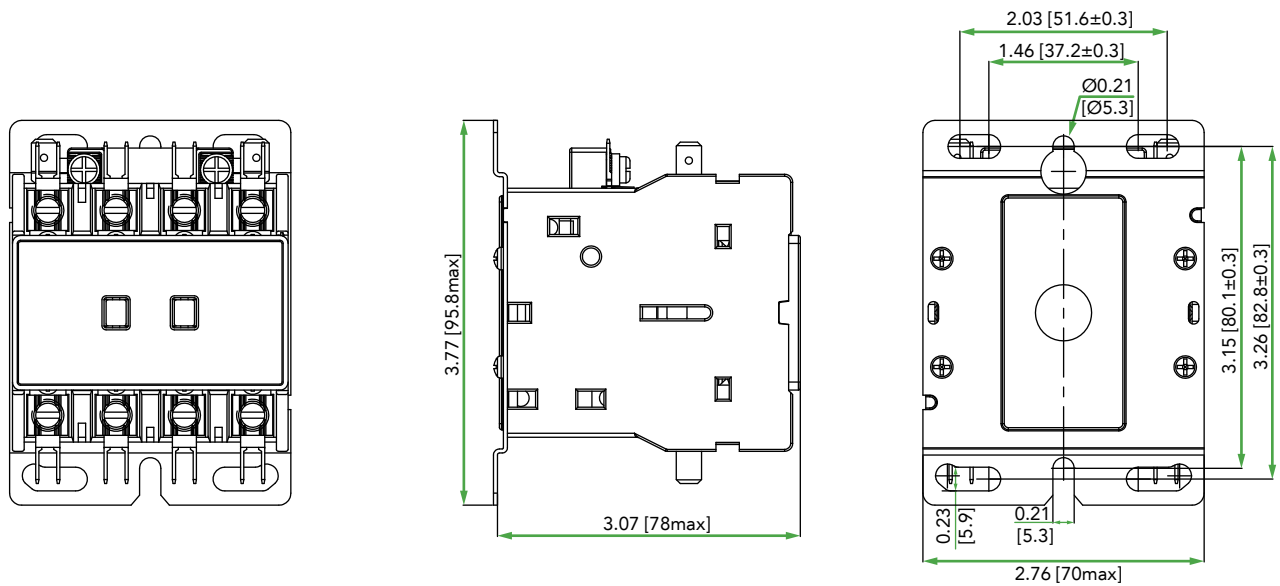

Definite Purpose Contactors Ex9CKT Wiring Diagram

Wiring Diagram

Ex9CKT20~40

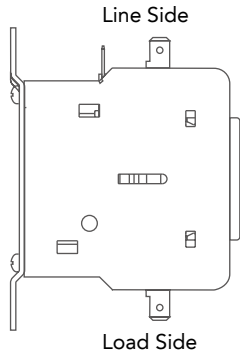

Ex9CKT20~40

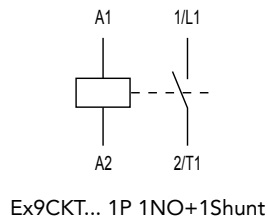

Ex9CKT20~40

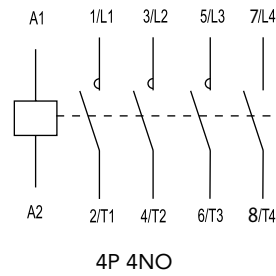
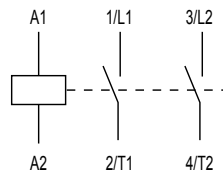
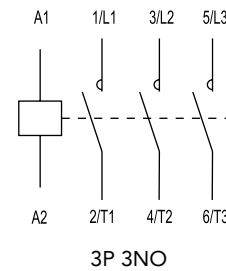

Ex9CKT20~40

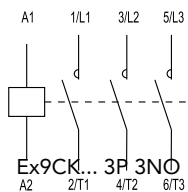

Ex9CKT20~40

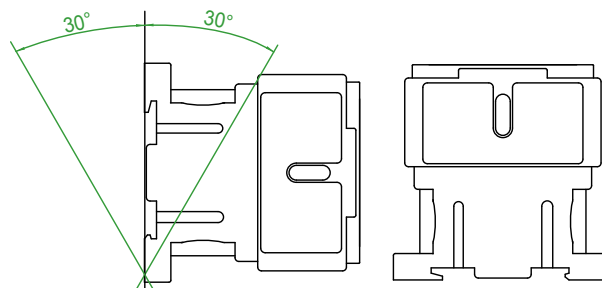

Definite Purpose Contactors

Ex9CKT Accessories and Specifications

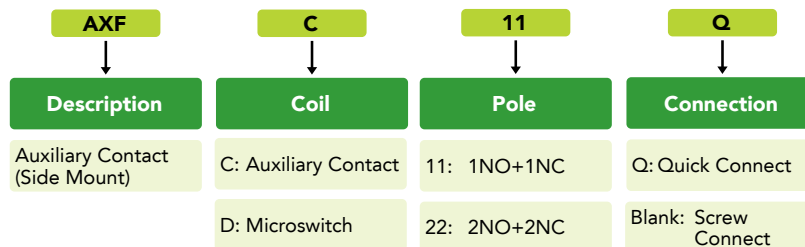

- Contact a NOARK sales representative for more information.

Accessory Description	Matched Contactor	Product	Part Number
Auxiliary Contact (Side Mount)	Ex9CK20~40 3P Ex9CKT20~40 3P & 4P	AXFC11	1311725
		AXFC11Q	1314051
Microswitch	Ex9CKT20~40 3P & 4P	AXFD11	1314052
		AXFD22	1314053

Auxiliary Contact	AXFC11/AXFC11Q	AXFD11	AXFD22	F
Microswitch	-	SPDT One Switch Per Side	SPDT Two Switches Per Side	
Mounting	Side Mounted (Maximum of two) Ex9CKT 20-40 Side Mounted Only	One Auxiliary Only		
	1NO+1NC	1NO+1NC	2NO+2NC	
Wiring	0.250 Quick Connection Terminals			
	#6~32 Screw Terminal	-		
Contact Ratings - AXFC				
Break (A)	120 Vac	3		
	240 Vac	1.50		
	480 Vac	0.75		
	600 Vac	0.60		
Make (A)	120 Vac	30		
	240 Vac	15		
	480 Vac	7.50		
	600 Vac	6		
Continuous (A)	120 Vac	10		
	240 Vac			
	480 Vac			
	600 Vac			
Contact Ratings - AXFD				
125 or 250 Vac	15A			
120 Vac on Lamp Load	4 A			
125 Vdc	1/2 A			
250 Vdc	1/4 A			

Definite Purpose Contactors

Ex9CKT Accessories Dimensions

AXFC11/AXFC11Q

Unit: in. [mm]

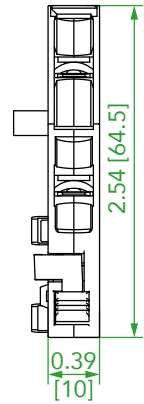
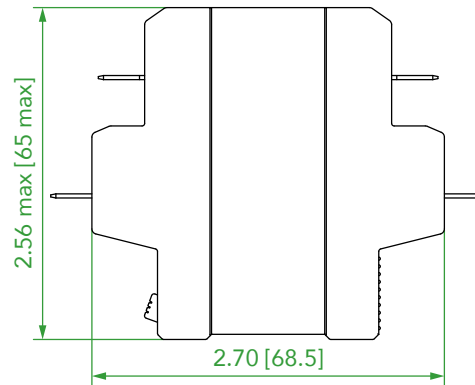
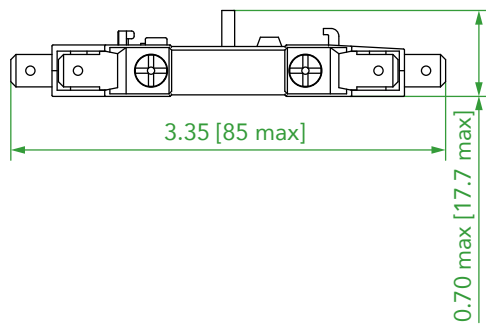

AXFD11/AXFD22

Unit: in. [mm]

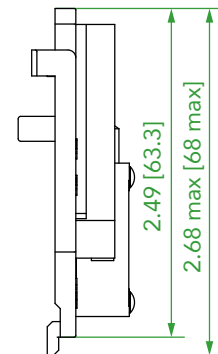
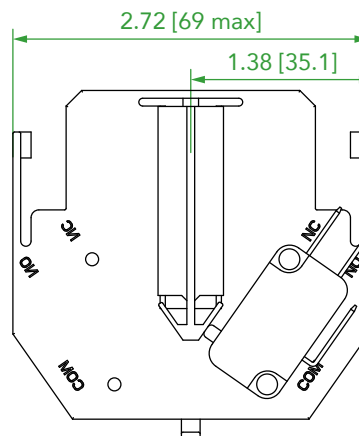
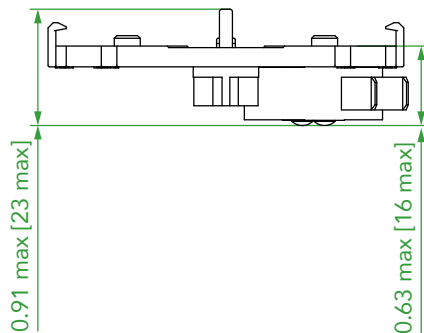

• Contact a NOARK sales representative for AXFB11 and AXFB11Q dimensions.

NOARK®

NOARK Electric North America
(626) 330-7007

na.noark-electric.com • nasales@noark-electric.com



Note: NOARK Electric reserves the right to make technical changes or modify the contents of this document without prior notice. With regard to purchase orders, the agreed particulars shall prevail. NOARK Electric does not accept any responsibility whatsoever for potential errors or possible lack of information in this document. NOARK Electric reserves all rights in this document and in the subject matter and illustrations contained therein. Any reproduction, disclosure to third parties or utilization of its contents – in whole or in parts – is forbidden without prior written consent of NOARK Electric.