

B2R

Miniature Circuit Breaker

1

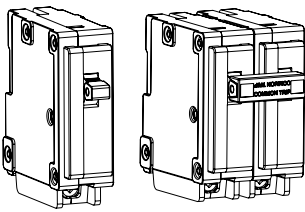



Installation Instructions
 Notice d'installation
 Instrucciones de montaje

NOARK

B2R

Single-wire connection

5

 Cable 1	a ≥ 6mm b ≥ 2.8mm
 Wire 1	#14AWG-#8AWG (2.5mm ² -10mm ²)
	20 lb-in (2.3 N·m)

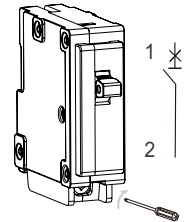

B2R

2



WARNING

DO NOT ATTEMPT TO INSTALL OR PERFORM MAINTENANCE ON EQUIPMENT WHILE IT IS ENERGIZED. DEATH, SEVERE PERSONAL INJURY, OR SUBSTANTIAL PROPERTY DAMAGE CAN RESULT FROM CONTACT WITH ENERGIZED EQUIPMENT. ALWAYS VERIFY THAT NO VOLTAGE IS PRESENT BEFORE PROCEEDING WITH THE TASK, AND ALWAYS FOLLOW GENERALLY ACCEPTED SAFETY PROCEDURES.

NOARK IS NOT LIABLE FOR THE MISAPPLICATION OR MISINSTALLATION OF ITS PRODUCTS

B2R

3

Bus Bar Connection

Mounting Hook

1

2

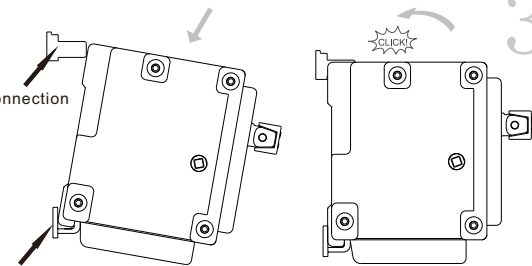

B2R

6

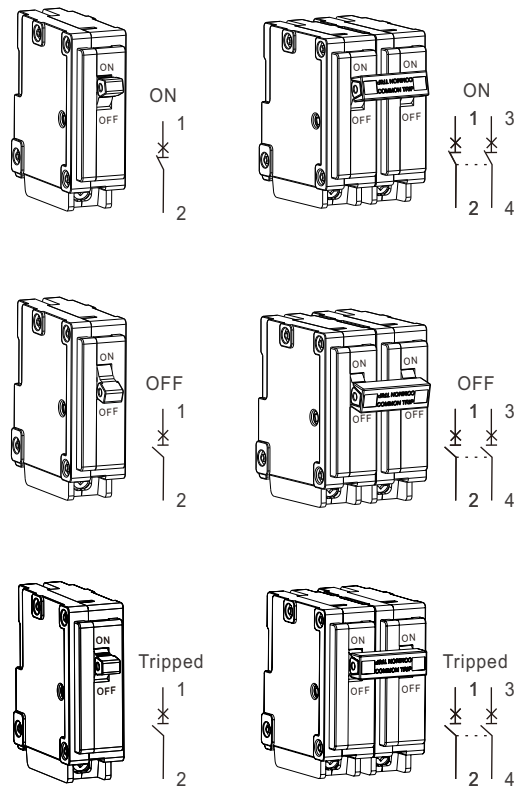

B2R

4

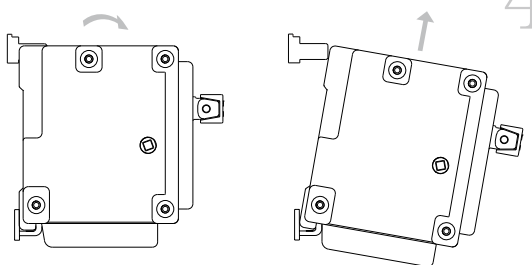

1

2

B2R

NOARK



In order to protect the environment, when the product or its components are scrapped, please dispose of it as industrial waste or hand it over to the recycling station for disaggregation, recycling and reuse according to relevant national regulations.

Printed with environmentally-friendly paper
 Copyright NOARK. All Rights Reserved

www.noark.cn

12/2023