









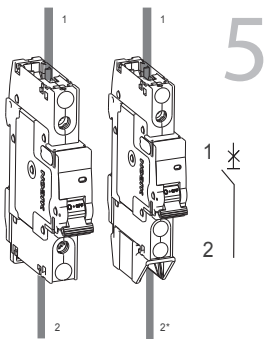

Single-wire connection

	 Z2
 Wire 1 and 2	#14AWG-#4AWG (2.5mm ² -25mm ²)
 Wire 2*	#14AWG-#10AWG (2.5mm ² -6mm ²)
	31 lb-in(3.5 N·m)



Multiple-wires connection

	 Z2
 Wire 1 and 3	#14AWG-#4AWG (2.5mm ² -25mm ²)
 Wire 2 and 4	#14AWG-#10AWG (2.5mm ² -6mm ²)
 Wire 2* and 4*	
	31 lb-in(3.5 N·m)

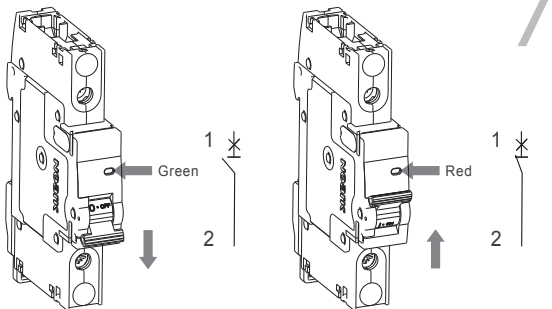
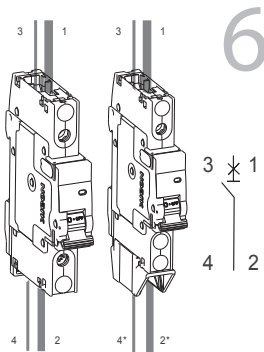

NOARK



Printed with environment-friendly paper

Copyright Noark.All Rights Reserved

www.noark-electric.com

05/2015

Miniature Circuit Breaker

1

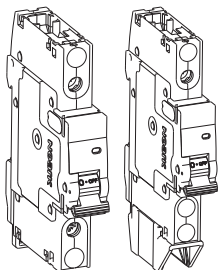

Installation Instructions

Notice d'installation

Instrucciones de montaje

NOARK

2



WARNING

DO NOT ATTEMPT TO INSTALL OR PERFORM MAINTENANCE ON EQUIPMENT WHILE IT IS ENERGIZED. DEATH, SEVERE PERSONAL INJURY, OR SUBSTANTIAL PROPERTY DAMAGE CAN RESULT FROM CONTACT WITH ENERGIZED EQUIPMENT. ALWAYS VERIFY THAT NO VOLTAGE IS PERSENT BEFORE PROCEEDING WITH THE TASK, AND ALWAYS FOLLOW GENERALLY ACCEPTED SAFETY PROCEDURES.

NOARK IS NOT LIABLE FOR THE MISAPPLICATION OR MISSINSTALLATION OF IT'S PRODUCTS

3

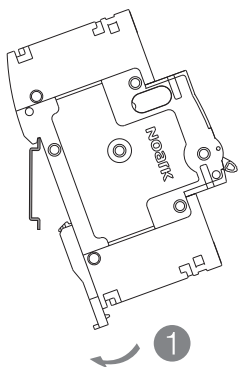
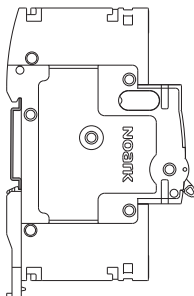
2
CLICK!

4

